



Wall Cladding Installation Guide

v20190524



CONTENTS

Important Note	2 - 3
Wall Cladding Parts	4 - 6
Under Construction and Framing	7 - 9
Wall Cladding Installation	
Option 1: Installing the Trims and then Boards	10 - 20
Option 2: Installing the all trims first and then dropping the boards in	20 - 29
Finishing the last board	
Option 1: F Trim	29
Option 2: Wall Cladding Board	29 - 30
Window Installation	30 - 32
Ceiling Installation	33 - 34

IMPORTANT:

Read All Sections Before You Start

For the most up to date information, please visit our website @ www.newtechwood.com

Prior to installing any composite cladding system, it is recommended that you check with local building codes for any special requirements or restrictions. The diagrams and instructions outlined in this guide are for illustration purposes only and are not meant or implied to replace a licensed professional. Any construction or use of NewTechWood must be in accordance with all local zoning and/or building codes. The consumer assumes all risks and liability associated with the construction and use of this product.

Safety

When dealing with any type of construction project, it is necessary to wear appropriate safety equipment to avoid any risk of injuries. NewTechWood recommends, but is not limited to the following safety equipment, when handling, cutting, and installing NewTechWood: gloves, a respiratory protection, long sleeves, pants, and safety glasses.

Tools

Standard woodworking tools may be used. It is recommended that all blades have a carbide tip. Standard stainless steel or acceptable coated deck screws and nails are recommended.

Environment

A clean, smooth, flat, and strong surface is needed to install NewTechWood's products correctly. Please check with local building codes before ever installing any type of cladding. If installation does not occur immediately, NewTechWood's products need to be put on a flat surface at all times. It should NEVER be put on a surface that is NOT flat.

Planning

Plan a layout for your cladding before starting it to ensure the best possible looking cladding for your project. Building codes and zoning ordinances generally apply to permanent structures, meaning anything that is anchored to the ground or attached to the house. So nearly every kind of cladding requires permits and inspections from a local building department. We recommend drawing out a site plan of your proposed project that you intend to do to minimize errors and make your perfect wall cladding.

Construction

NewTechWood UltraShield is NOT intended for use as columns, support posts, beams, joist stringers or other primary load-bearing members. NewTechWood must be supported by a code-compliant substructure. While NewTechWood products are great for retrofits, NewTechWood's products CANNOT be installed on existing cladding boards.

Static

Static can also be more prevalent in areas that are of higher altitude because the humidity is lower. For these areas, be careful of using conducive objects such as metal railing and chairs as static shocks might occur more often. A potential way to lower the amount of static shocks occurring is to apply Staticide

(www.aclstaticide.com) on your deck or use anti-static mats before doorways.

Ventilation

NewTechWood products CANNOT be directly installed onto a flat surface. It must be installed onto a substructure, so there is adequate and unobstructed air flow under the cladding to prevent excessive water absorption. A minimum of 25 mm (1 inch) of continuous net free area under the cladding surface is required for adequate ventilation on all cladding, so air can circulate between adjacent members to promote drainage and drying.

Heat and Fire

Excessive heat on the surface of NewTechWood products from external sources such as but not limited to fire or reflection of sunlight from energy efficient window products. Low-emissivity (Low-E) glass can potentially harm NewTechWood products. Low-E glass is designed to prevent passive heat gain within a structure and can cause unusual heat build-up on exterior surfaces. This extreme elevation of surface temperatures, which exceeds that of normal exposure, can possibly cause NewTechWood products to melt, sag, warp, discolor, increase expansion/contraction, and accelerate weathering.

Current or potential NewTechWood customers that have concerns about possible damage by Low-E glass should contact the manufacturer of the product, which contains Low-E glass for a solution to reduce or eliminate the effects of reflected sunlight.

Fasteners



When fastening NewTechWood's products all screws that are face fastened should always be driven in at a 90 degree angle to the cladding surface. Toe nailing/screwing should never be done to the products. An extra joist should be added if a 90 degree angle cannot be driven into the board. All fasteners should be on their own independent joists, when two boards ends meet each other there must be a sister joist. The end of each board must sit on its own joist.

Use white chalk, straight boards, or string lines as templates for straight lines. NEVER USE COLORED CHALK. Colored chalk will permanently stain NewTechWood's products and are highly not recommended.

All nails/screws that are face fixed should always be stainless steel. Depending on the screws that you use when face fixing, there could be potential bulging or mushrooming. It is recommended to take care of these mushrooms/bulges by taking a rubber mallet and patting them down to give your cladding a better look.

When choosing which screws/nails to use always check first with your local home centers and hardware stores to see if they have screws that are engineered specifically for composite wood. These screws/nails will always work and give NewTechWood's products the best looking outcome, using other screws/nails that are not recommended for composite could potentially damage/harm the cladding. If you are unsure which screw/nail to use, contact your manufacturer for more information.

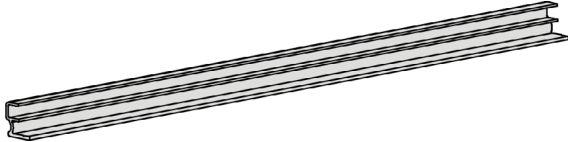
Wall Cladding Parts

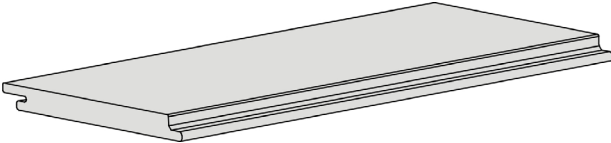
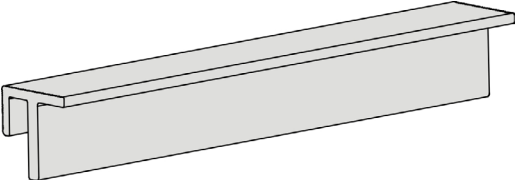
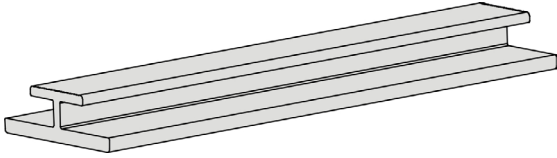
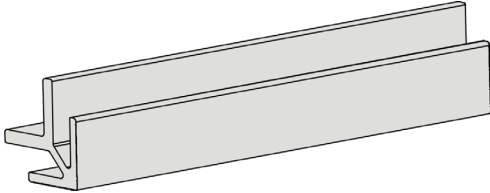
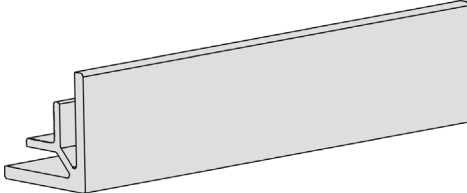
Product	Purpose	Part
AW-02	Used for the installation of the first board	
AW-08	Used at every joist to fix each board to the joist	
T-7	Used on the last wall cladding board	
US09	Wall Cladding Board (can be used in place of US30, US31)	
US44	F-Trim, used at the windows	
US45	I-Trim, used if there is a break between two boards to cover up the gap	
US46	Outside Corner Trim, used on the outside corners	
US47	Inside Corner Trim, used on the inside corners	

Wall Cladding Screws (For Wood Joist)



Product	Purpose	Part
<p>*M3 x 12 SS304</p>	<p>Used when locking the board into AW08</p>	
<p>*M4 x 80** SS304 **depends on the thickness of your joists</p>	<p>Used when installing the joist to the wall</p>	
<p>*M4 x 20 SS304 (pan head)</p>	<p>Used when installing AW08 into wood joists</p>	
<p>*M4 x 20 SS304 (flat head)</p>	<p>Used when installing trims into wood joists</p>	

table 1

Wall Cladding Screws (For Aluminum Joist)

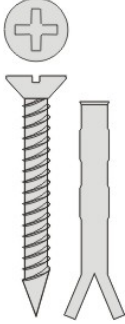

Product	Purpose	Part
*M3 x 12 SS304	Used when locking the board into AW08	
*M4 x 80** SS304 **depends on the thickness of your joists	Used when installing the joist to the wall	
*M4 x 20 SS410 (pan head)	Used when installing AW08 into aluminum joists	
*M4 x 20 SS410 (flat head)	Use when installing trims into aluminum joists	

table 2

*Note: All screws are based on our recommendation and if the installation requires something different than what is shown, a professional should be consulted before installing.

The following installation guide will use the above screw sizes.

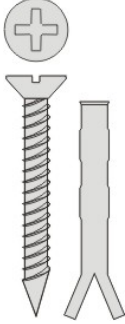
Under Construction

We recommend for the under construction aluminum or pressure treated wood joists. Each cladding board needs to be supported by a joist NO MORE than 500 mm (1.64 feet) from center to center. Extra care is required in order to provide sufficient joisting in and around obstacles such as windows, fascia's, soffits, guttering, ventilation points etc. Below is an example of the layers that would occur in a typical installation, but a licensed professional should always be consulted prior to any installation.

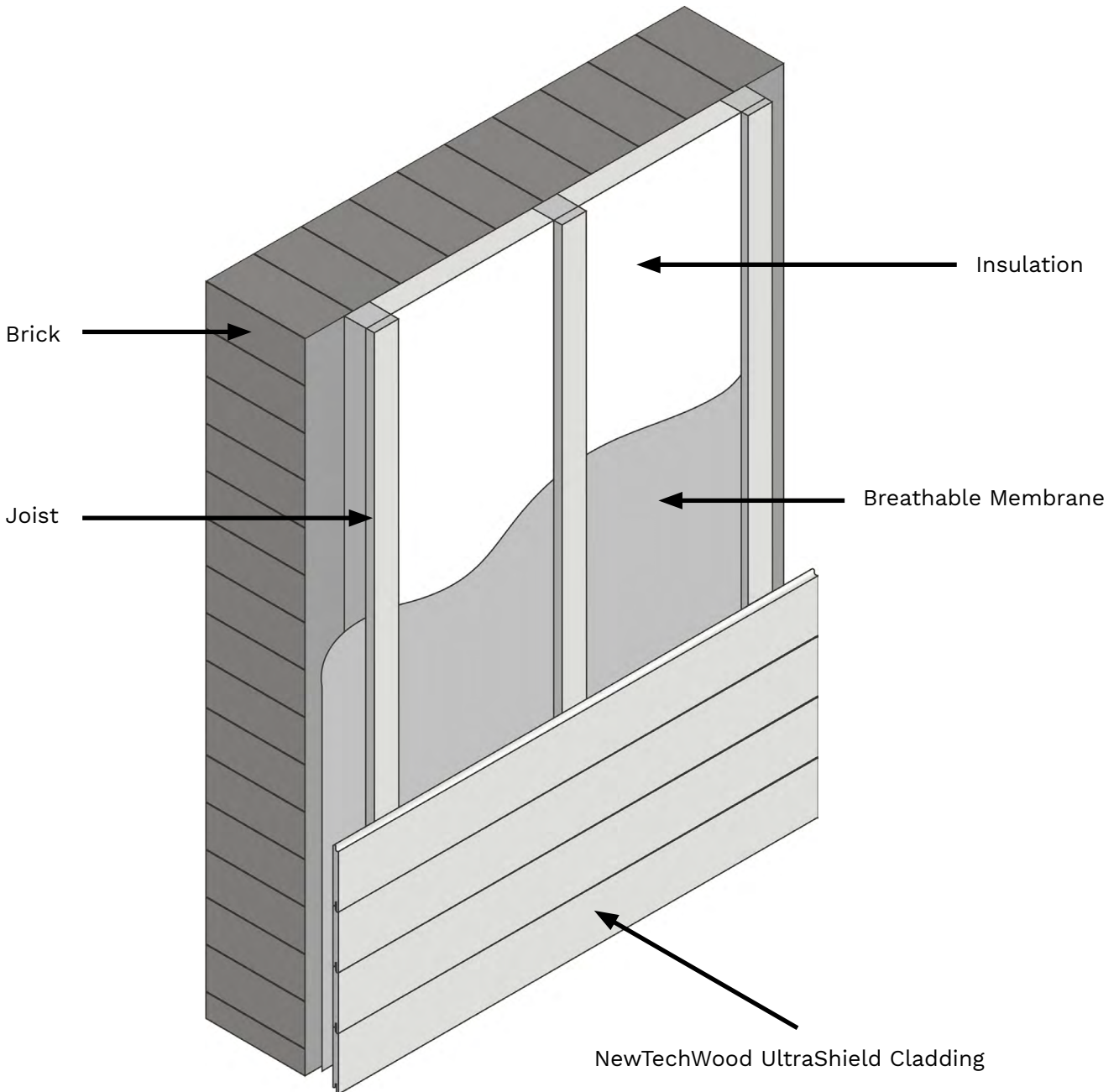

Joist Installation

A building professional should be consulted regarding vapor barriers and insulation for your project. Where a vapor barrier is to be used, it should be a breathable type and must be positioned behind the joists. The joist needs to have a minimum thickness of 1 inch (25 mm).

Wood joists should be fixed into position at a maximum of 1.64 feet centers using a suitable A4 Stainless Steel Countersunk Wood/Masonry screw. All joists needs to be flat and leveled against the wall surface use shims if necessary.

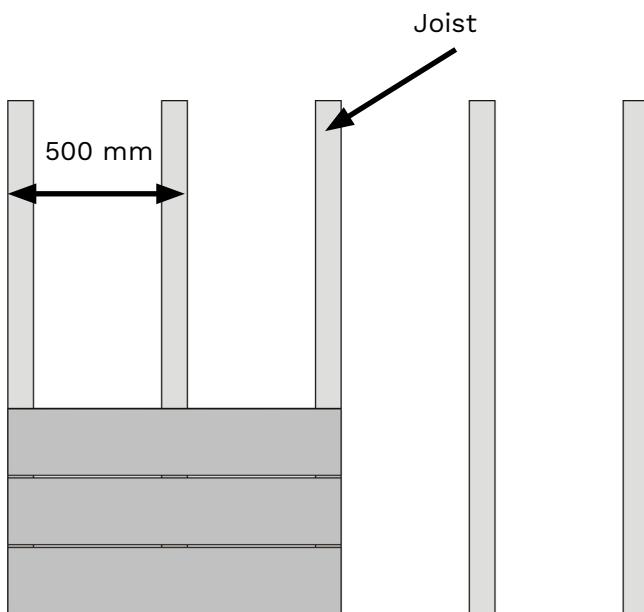

Horizontal Installation

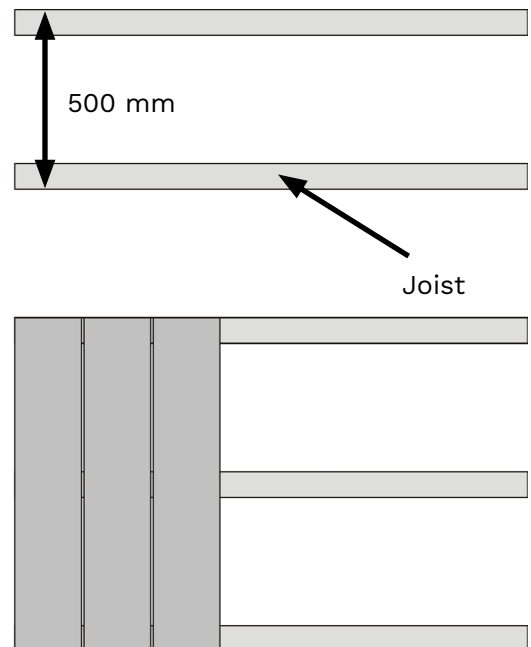

Vertical Installation

Locking the Wall Cladding Board

Every AW-08 clip comes with a separate hole in the case there is a need to lock the board. The wall cladding boards will expand and contract and to take care of this movement, we must lock the board in one position and then allow the board to expand and contract readily in the other direction.

You can see how we lock the board in Diagram 1, 2, and 3.

Note: DO NOT LOCK EVERY BOARD. General rule of thumb is every board will only need one locking/fixation point.

Note: We recommend using the I Trim if you need to butt joint more than two boards together.

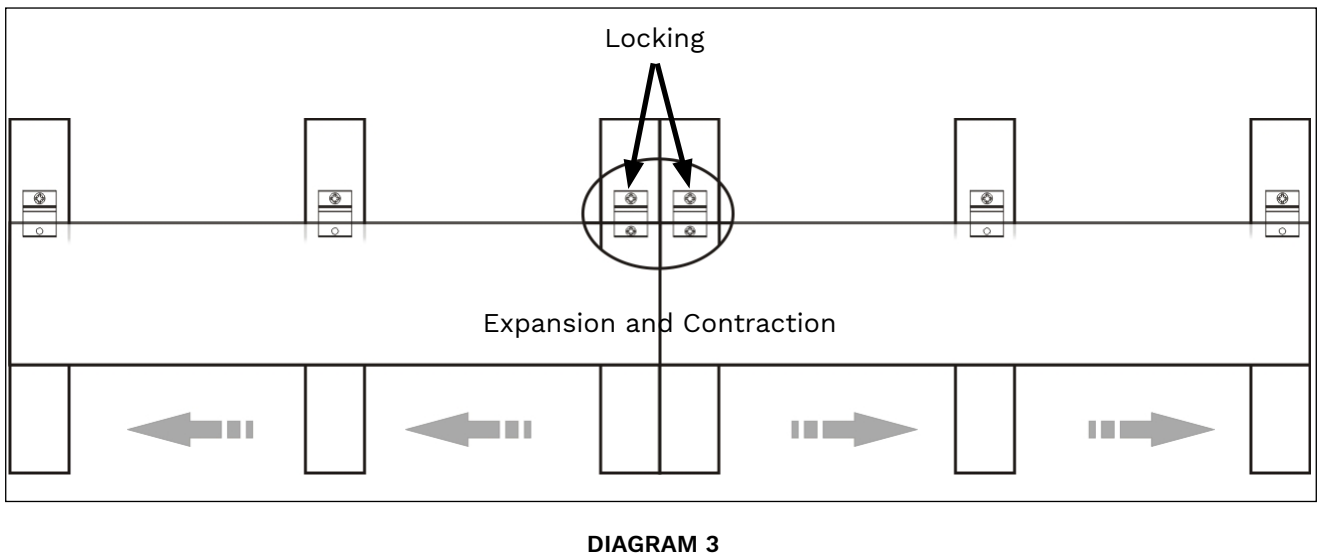
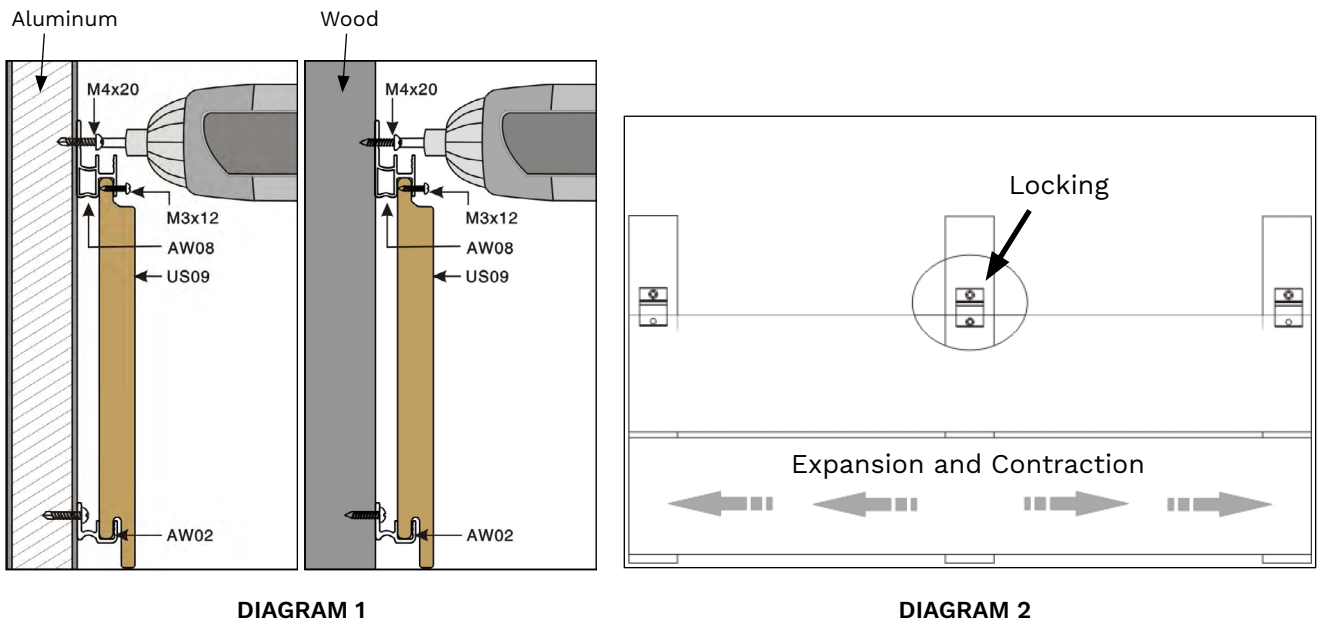

Framing

The frame needs to be completely level before installing any wall cladding boards.

Note: Adequate spacing in the joists is required to keep the cladding boards from bending. Please review page 7 of this installation guide to see what spacing is required.

The wall as shown in Diagram 4 will be installed to replicate different scenarios potentially occurring when installing the wall cladding.

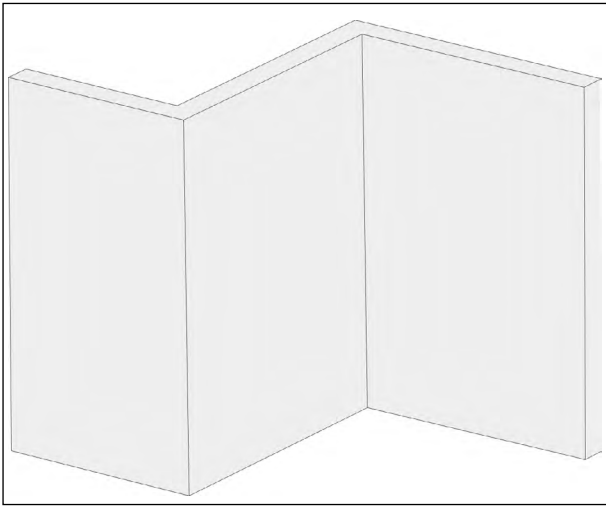

DIAGRAM 4

- 1 First start by fixing the joist onto the wall you plan to install on.

Noted: We are using wood joists to this installation. If you are using aluminum joists, please refer to table 2 on page 6 for the correct recommended screws.

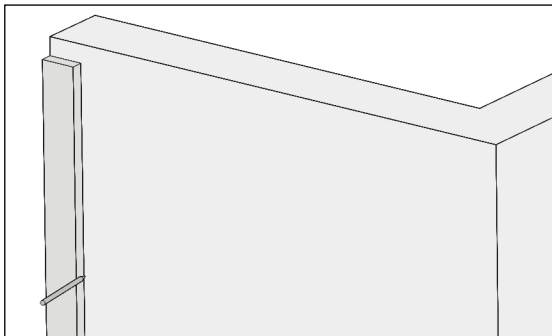

DIAGRAM 5

- 2 Next, the span needs to be measured for the next joist. Please review page 6 for the maximum span allowed from the center of center of each joist.

Diagram 7 shows the final installation of the first joist.

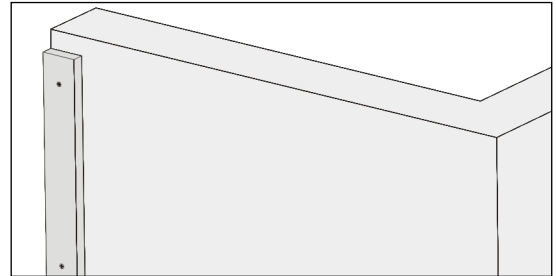

DIAGRAM 6



DIAGRAM 7

Option 1:
Installing the Trims and then Boards

Inside Corner Trim

- 1 The inside corner will be installed as shown in Diagram 8 by first pre drilling and then fixing with screws.



DIAGRAM 8

Diagram 9 is an above cross section view of the inside corner after installation. The inside corner was first installed onto the joists and then the boards were slotted into both openings when installed.

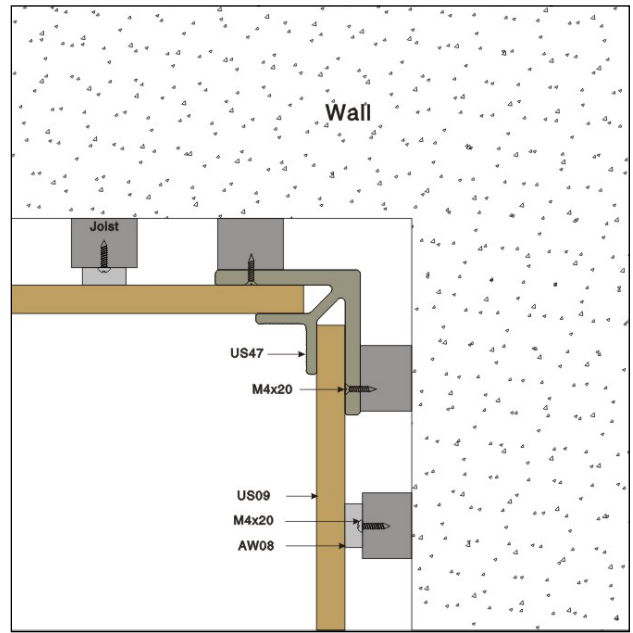

DIAGRAM 9

Starting Strip

- 1 The starting strip will now be installed on the bottom of the joists as shown in Diagram 10 by first pre drilling into the AW-02 and then fixing with screws.
- 2 Repeat step 1 and install the rest of the starting strip onto the rest of the joists. The finished starting strip across the joists can be see in Diagram 10.

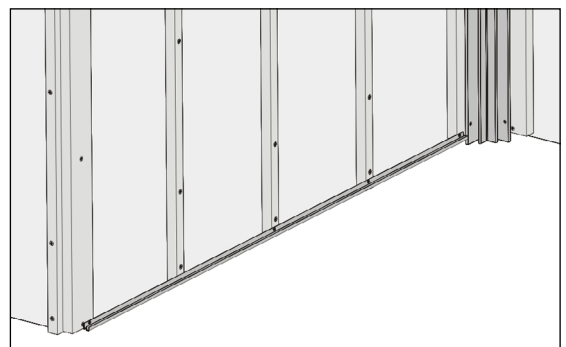

DIAGRAM 10

Wall Cladding Board

- 1 Take a wall cladding board and place the side with the lip down as shown in Diagram 11.

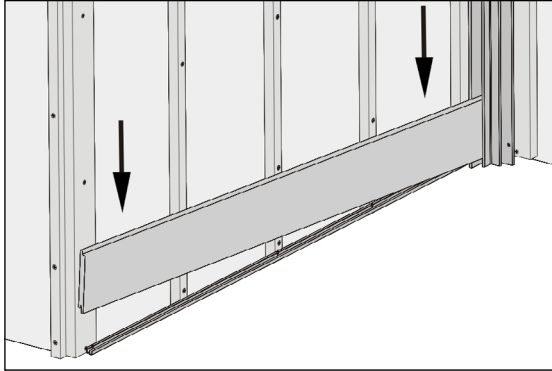

DIAGRAM 11

- 2 Place the AW-08 on the board and install with screws as shown in Diagram 12. Please review page 9 of this installation guide on how to lock the board with AW-08.

Note: A gapping of at least 10 mm needs to be left at the bottom of the ground and the lip of the board to allow for expansion and contraction and ventilation.

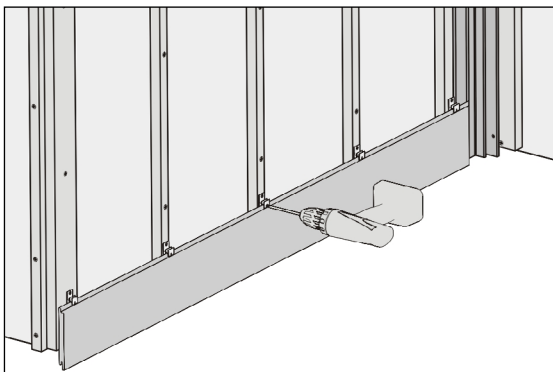

DIAGRAM 12

- 3 When you are on the last board of the wall cladding you will need to first install T-7. The T-7 will be installed onto every joist first and then the wall cladding board will be installed like normal as shown in Diagram 13.

Note: The T-7 is used as a place holder for the last board, so that the board will not slant.

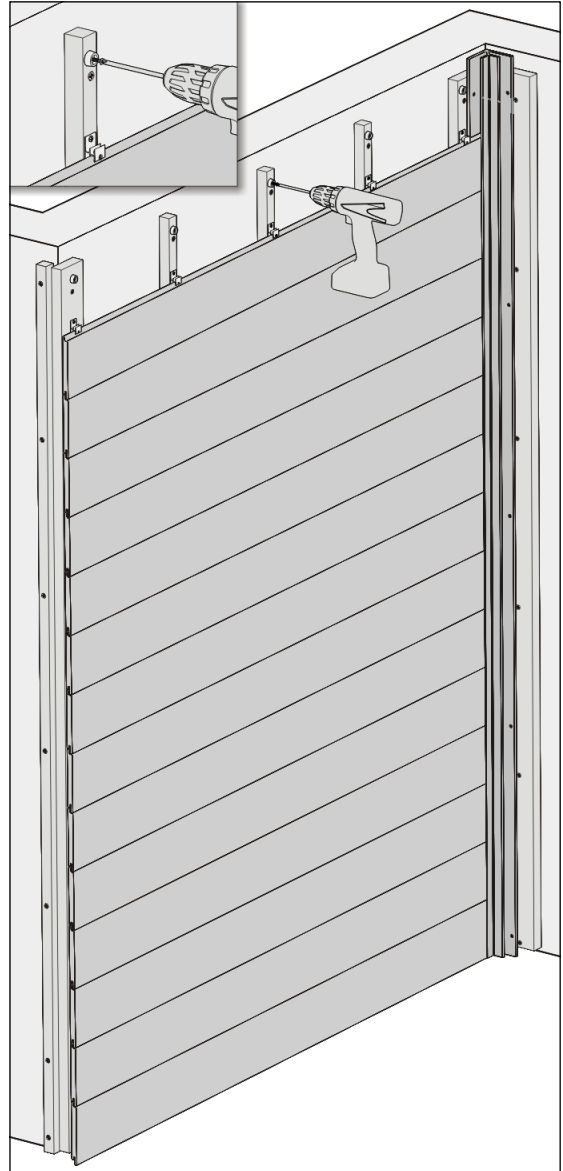

DIAGRAM 13

- 4 After installing the last board, the wall cladding should look like Diagram 14.

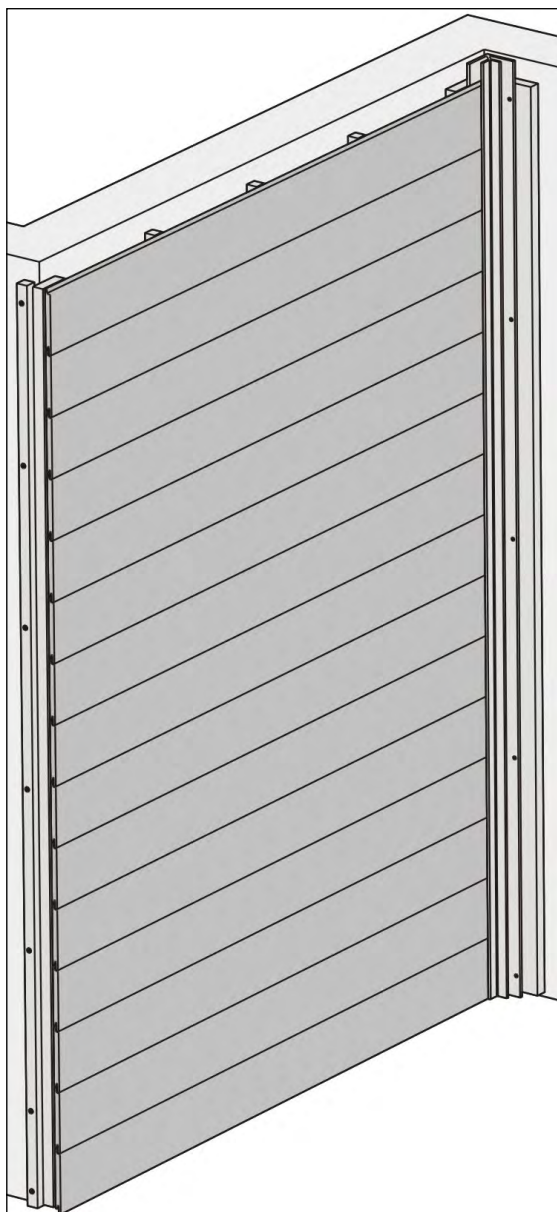

DIAGRAM 14

Outside Corner Installation

- 1 Next, take the outside corner and fix it to the side of the wall cladding that is open as shown in Diagram 15.

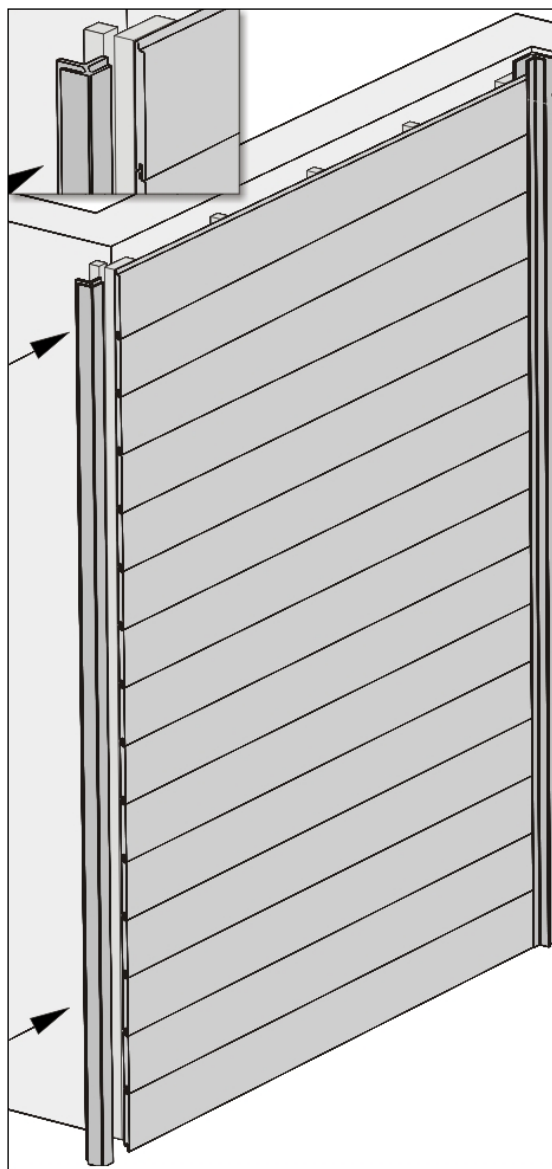

DIAGRAM 15

- 2 Fix the outside corner by screwing on the opposite face of the outside corner.

Note: Always pre-drill before screwing unless using composite screws designed for non pre-drilling. The distance between each screw should be no more than 300 mm center to center.

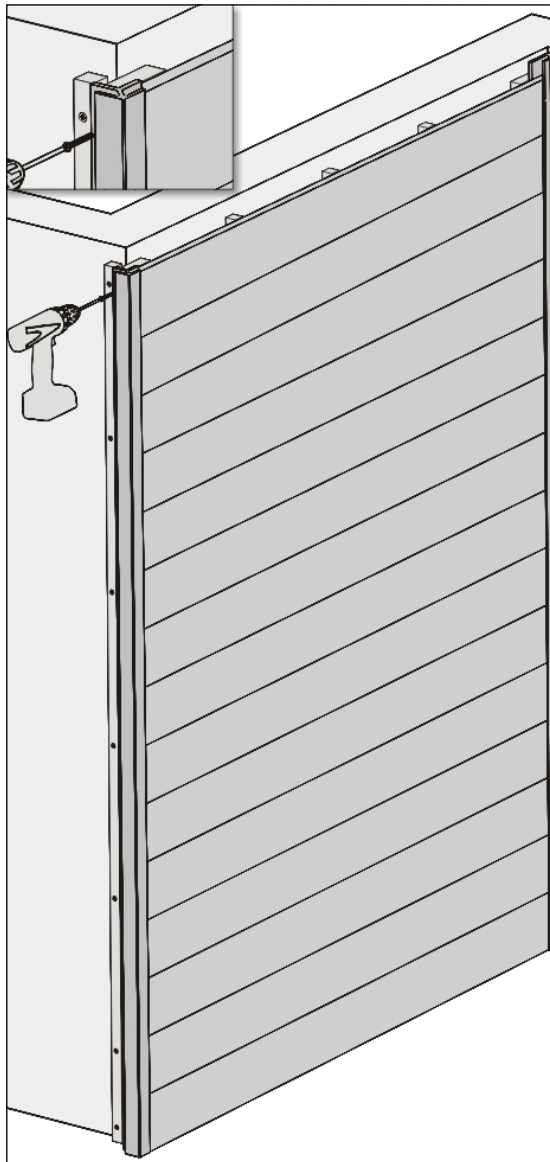

DIAGRAM 16

Diagram 17 is an above cross section view of the outside corner after installation. The outside was installed after the wall cladding was installed on one of the walls. Then, the outside corner was pushed into the opened side of the wall cladding and screw fixed from the other side.

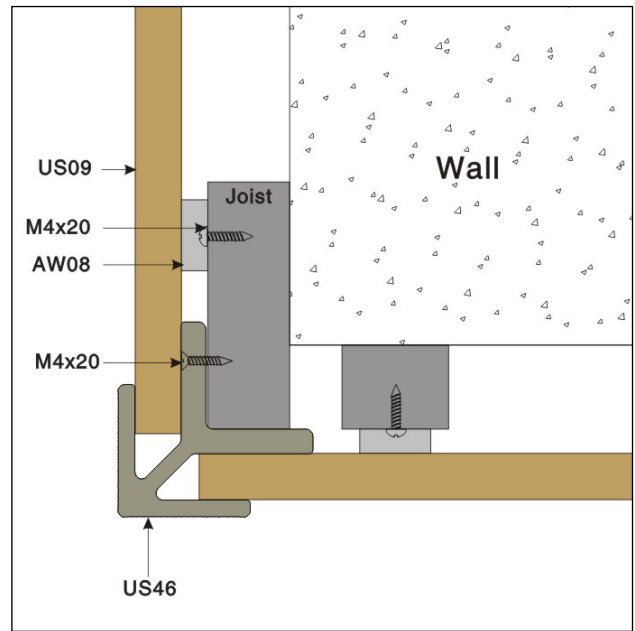

DIAGRAM 17

Wall Cladding Board

- 1 Now you are ready to install the other side of the wall as Diagram 18. Repeat steps 1-2 of starting strip on page 11 of this installation guide.

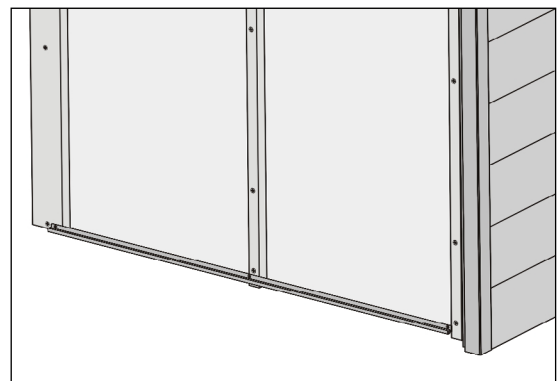

DIAGRAM 18

- 2 Then, repeat steps 1-3 of wall cladding board on page 12 of this installation guide. Continue to the top for a final finish as shown in Diagram 20.

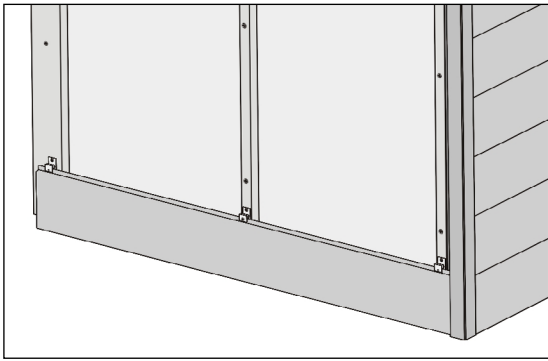

DIAGRAM 19

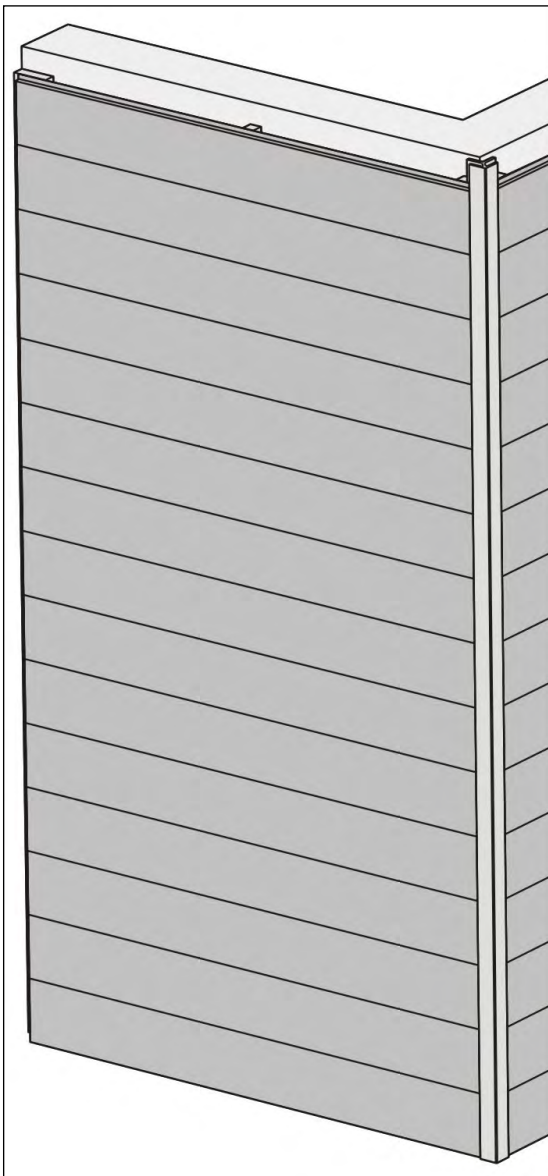

DIAGRAM 20

F Trim Installation

- 1 An F trim can now be used to finish off the open side of this wall cladding as shown in Diagram 21 and 22.

Note: Always pre-drill before screwing unless using composite screws designed for non pre-drilling. The distance between each screw should be no more than 300 mm center to center.

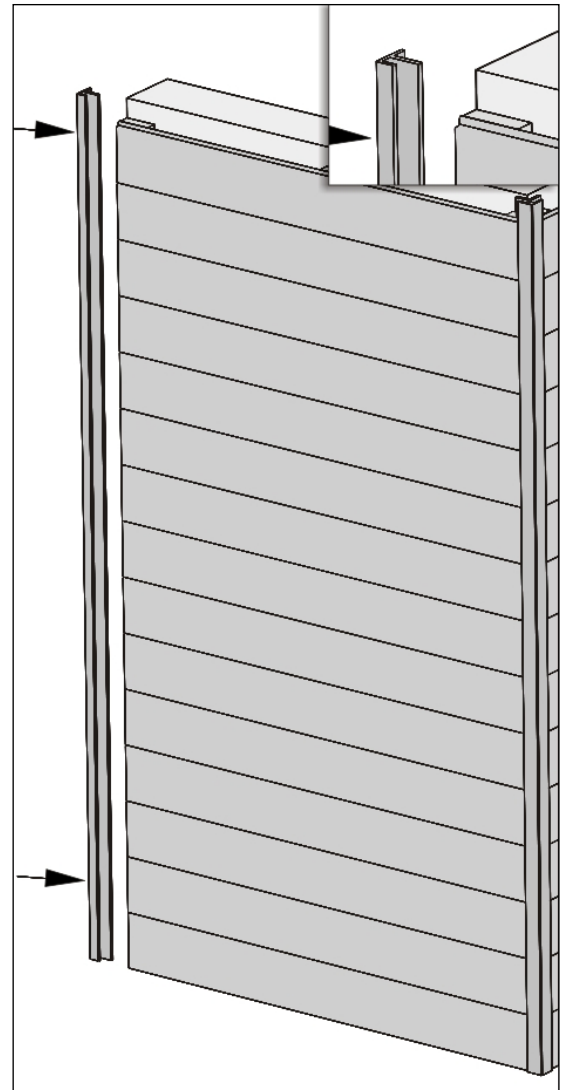

DIAGRAM 21

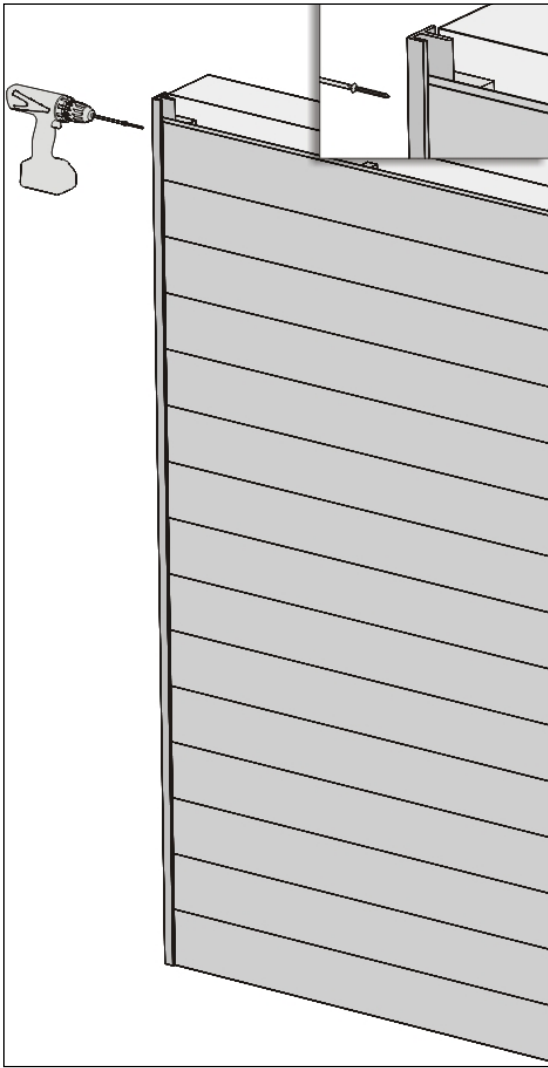

DIAGRAM 22

Diagram 23 is an above cross section view of the F trim after installation. The outside was installed after the wall cladding was installed on one of the walls. Then the F trim was pushed into the opened side of the wall cladding and then screw fixed from the other side.

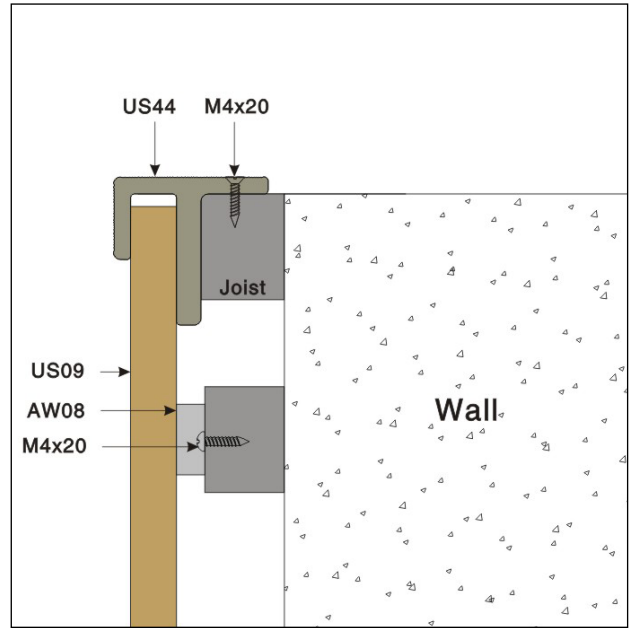

DIAGRAM 23

Wall Cladding Board

- 1 Now the other side of the inside corner wall will be installed. First, attach the AW-02 at the bottom of the wall as steps 1-2 of starting strip on page 11 of this installation guide.

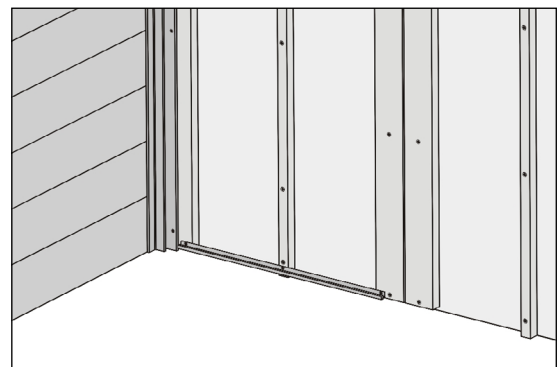

DIAGRAM 24

- 2 Then, install the wall cladding boards as shown in Diagram 25 by repeating the steps 1-3 of wall cladding board on page 12 of this installation guide.

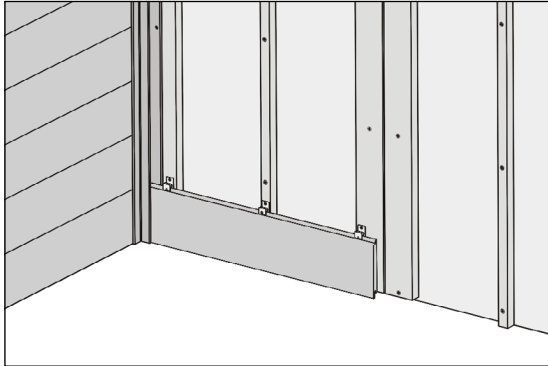

DIAGRAM 25

- 3 Continue to install the wall cladding boards until the top is reached as shown in Diagram 26.

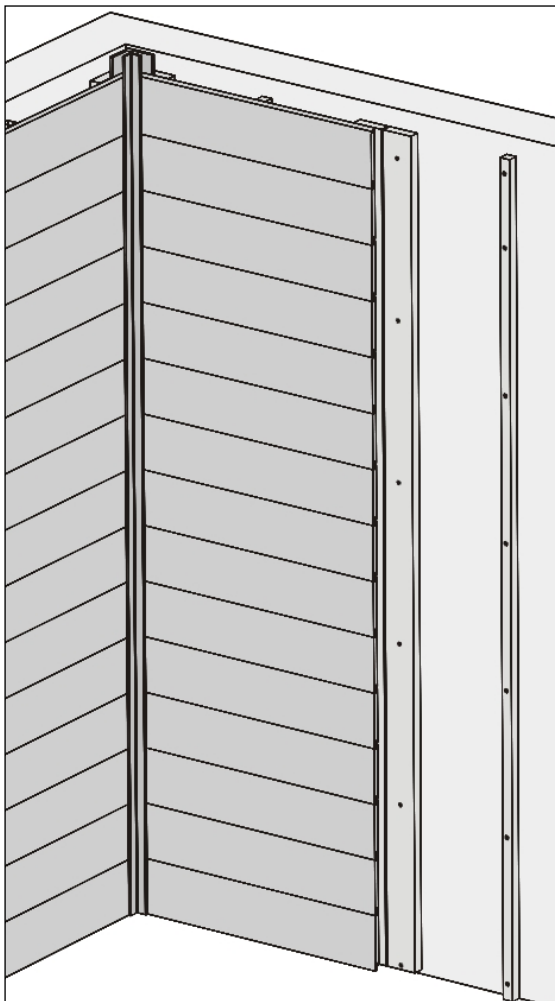

DIAGRAM 26

I Trim Installation

- 1 Using the I trim install the I trim on the opened side of the wall cladding as shown in Diagram 27.

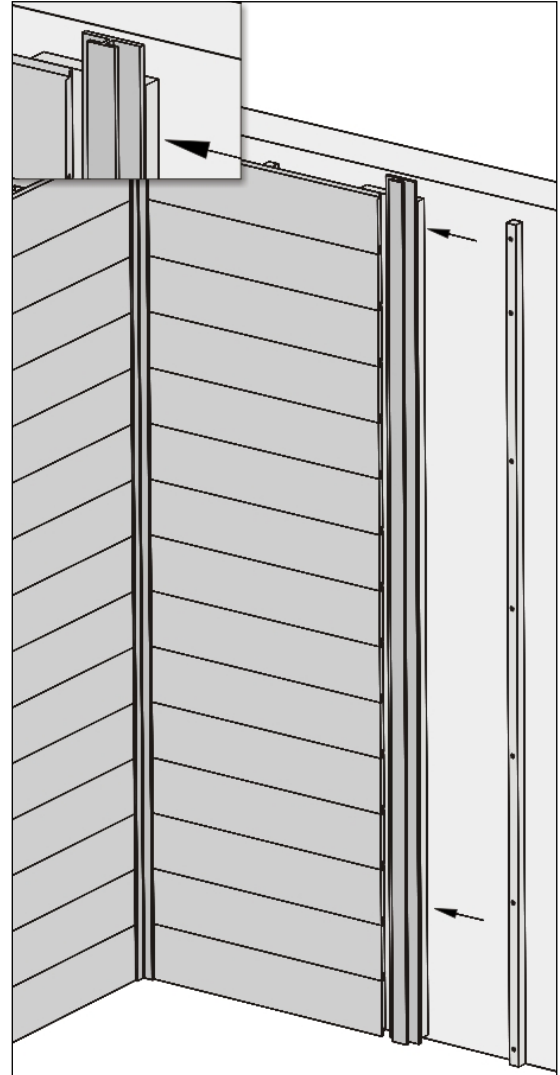

DIAGRAM 27

- 2 Fix the I trim to the joist by screw fixing the I trim and joist.

Note: Always pre-drill before screwing unless using composite screws designed for non pre-drilling. The distance between each screw should be no more than 300 mm center to center.

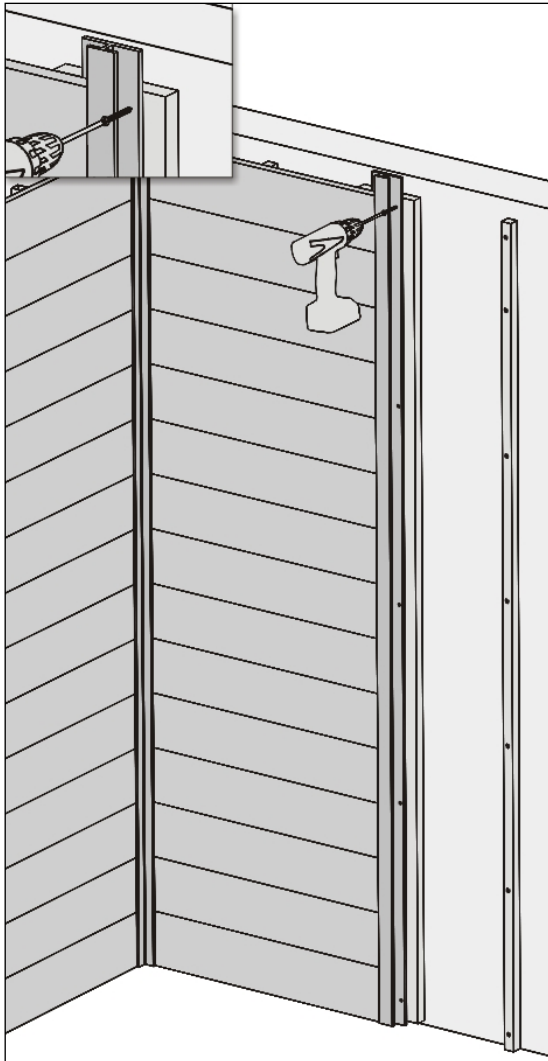

DIAGRAM 28

Wall Cladding Board

- 1 Repeat steps 1-2 of starting strip on page 11 of this installation guide on the section shown in Diagram 29.

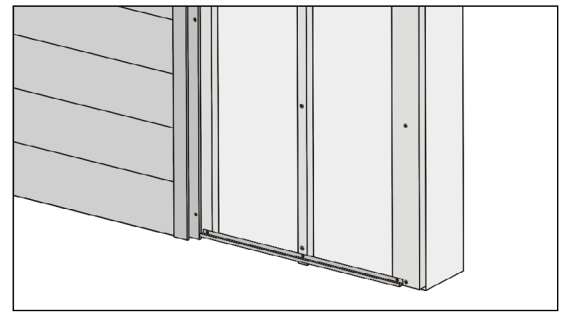

DIAGRAM 29

- 2 Next install the wall cladding board on top of the AW-02 and install the clips as steps 1-3 of wall cladding board on page 12 of this installation guide.

Note: A gapping of at least 10 mm needs to be left at the bottom of the ground and the lip of the board to allow for expansion and contraction and ventilation.

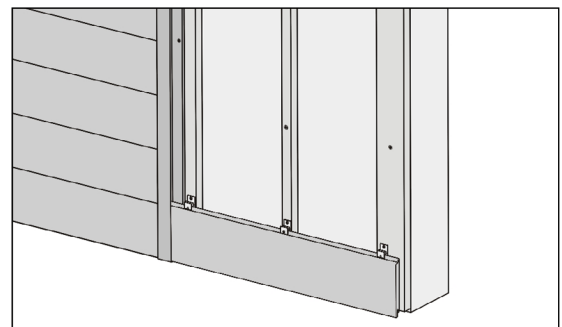

DIAGRAM 30

- 3 Install the rest of the wall cladding boards to the top as shown in Diagram 31.

Diagram 32 is an above cross section view of the I trim installed. The I trim was installed after the wall cladding was installed onto the wall. The I trim then comes in from the side and is screw fixed to the joist on the other side of the I. Alternatively, the I trim can be installed first by screw fixing and then have the wall cladding boards come in afterwards but this would require the distance of your cladding project pre-calculated.

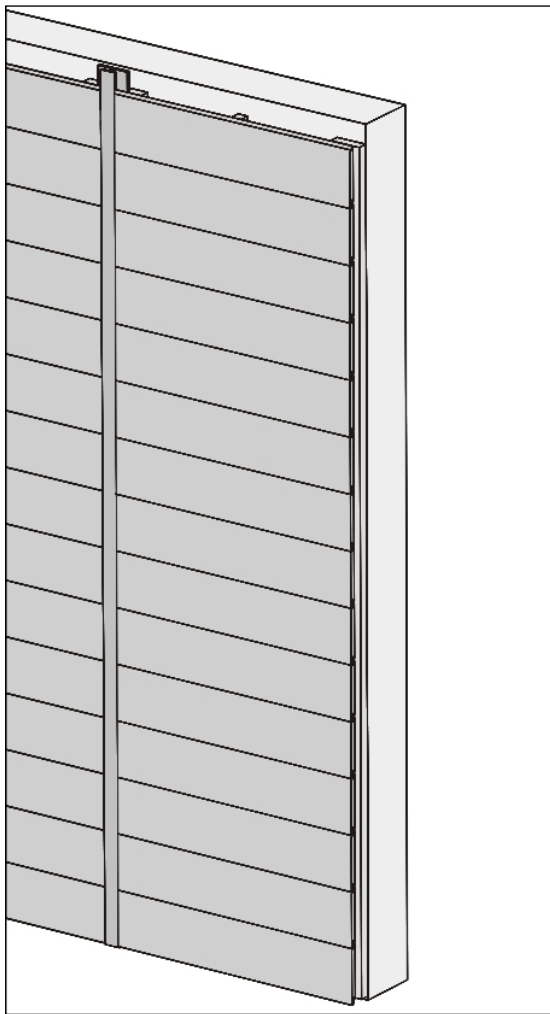

DIAGRAM 31

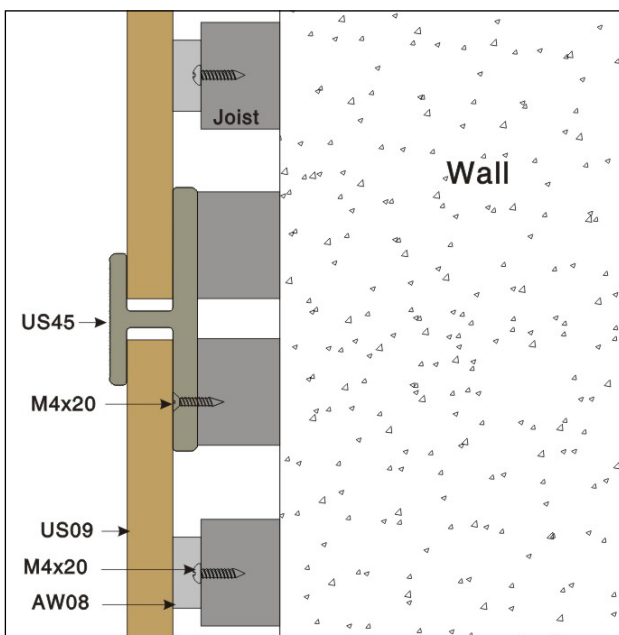

DIAGRAM 32

F Trim Installation

- 1 Install the F trim on the open side of the wall cladding as shown in Diagram 33.

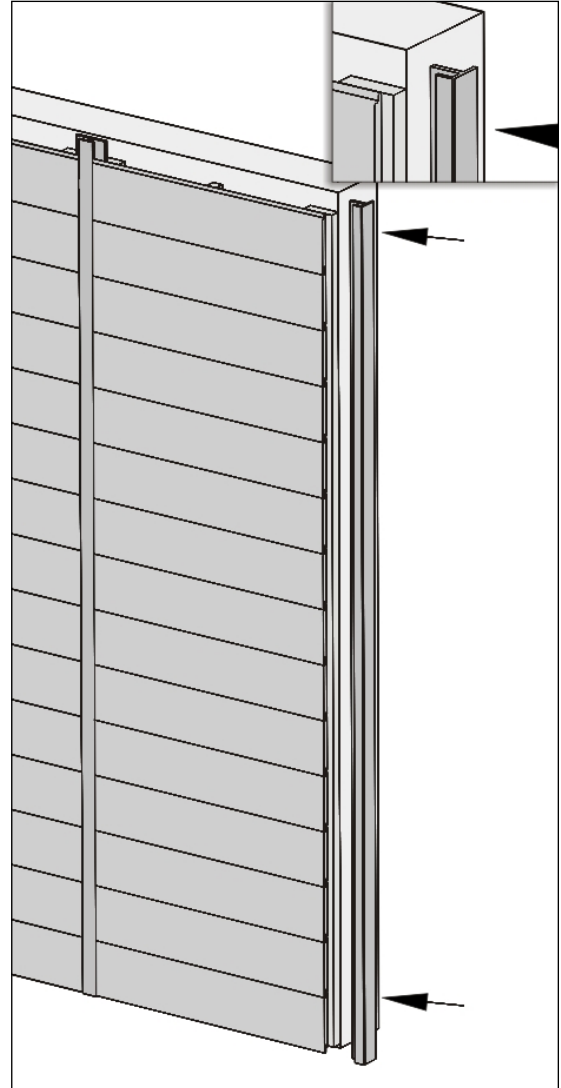

DIAGRAM 33

- 2 Fix the F trim to the joist by screw fixing into the F trim to the joist as shown in Diagram 34.

Note: Always pre-drill before screwing unless using composite screws designed for non pre-drilling. The distance between each screw should be no more than 300 mm center to center.

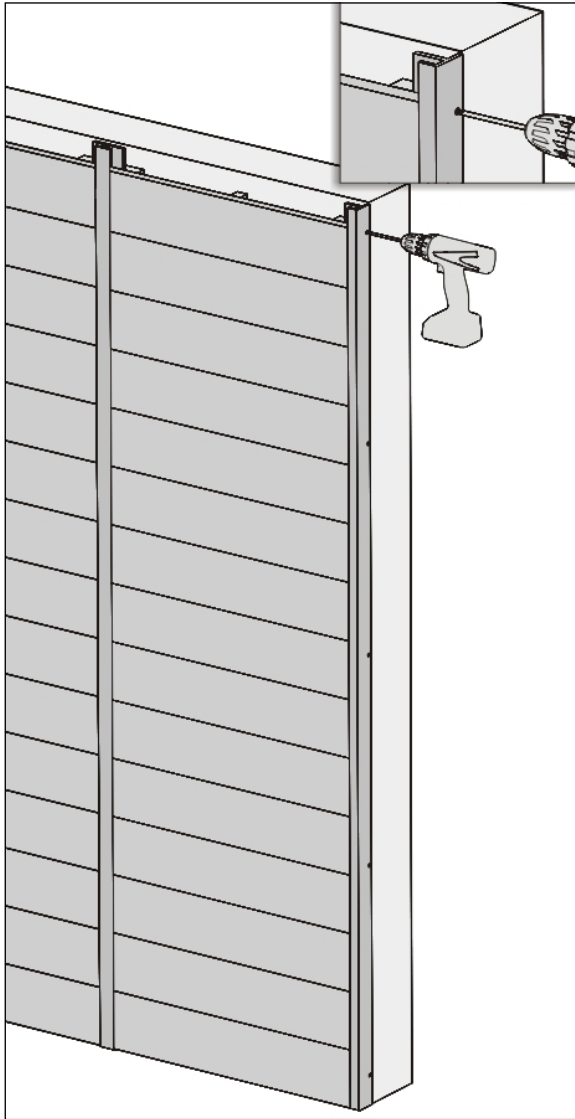

DIAGRAM 34

- 3 After completing all walls you should have the following installation as shown in Diagram 35.

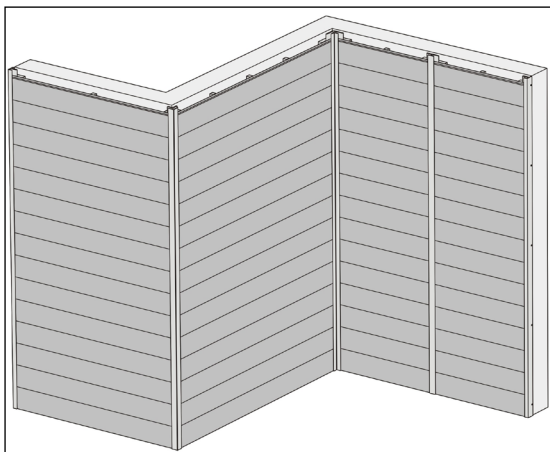

DIAGRAM 35

Option 2:

Installing the all trims first and then dropping the boards in

Inside Corner

- 1 The inside corner will be installed as shown in Diagram 36 by first pre drilling and then fixing the screws.

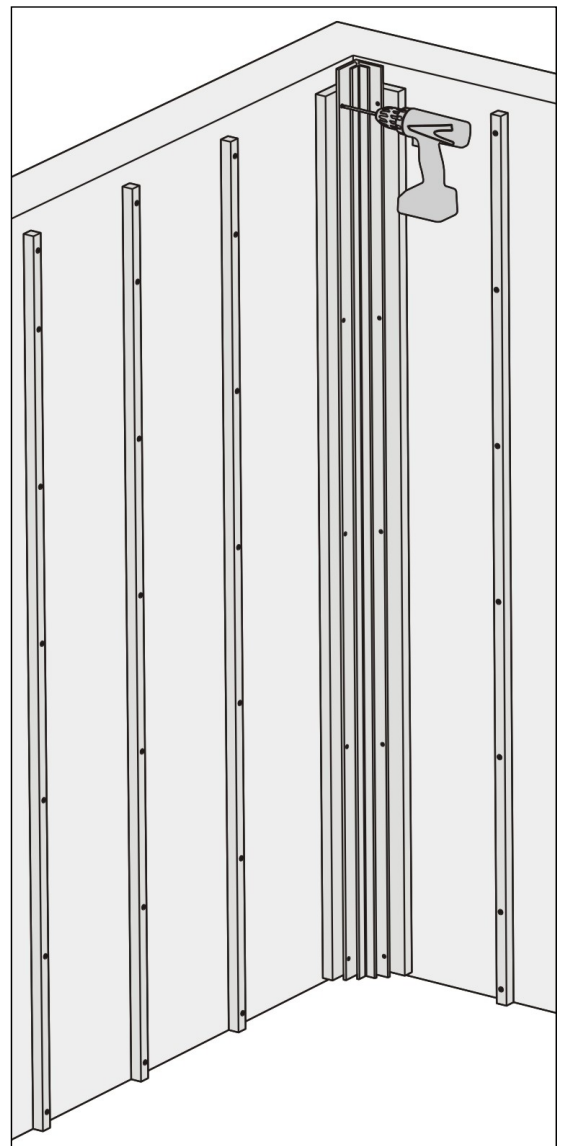

DIAGRAM 36

Outside Corner

- 2 The outside corner will be then be installed next as shown in Diagram 37.

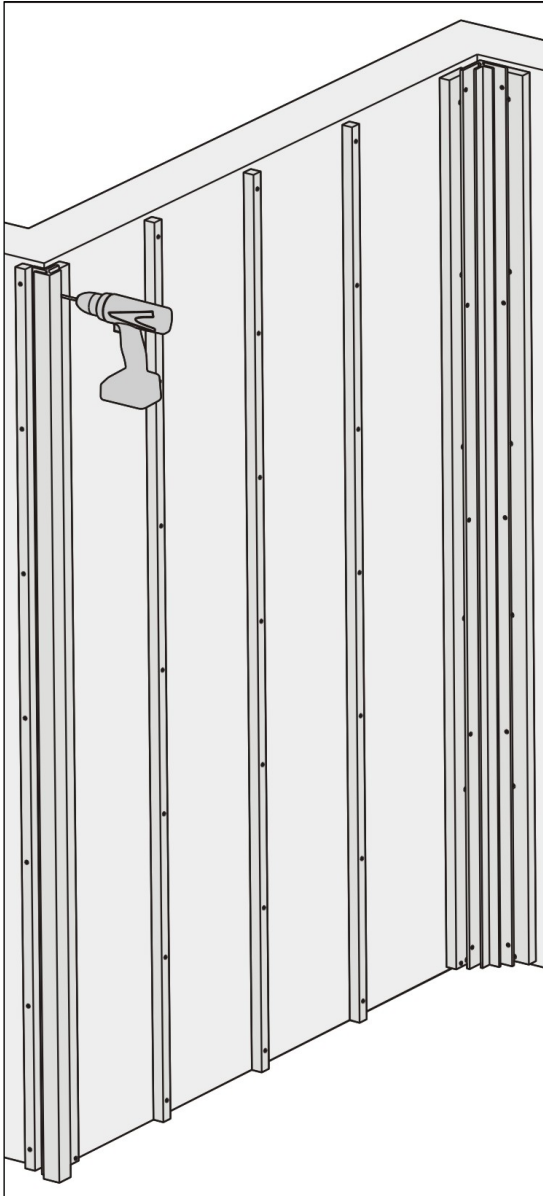

DIAGRAM 37

Diagram 38 is an above cross section view of the outside corner after installation. The outside corner was first installed onto the joists and then the boards were slotted into both openings when installed.

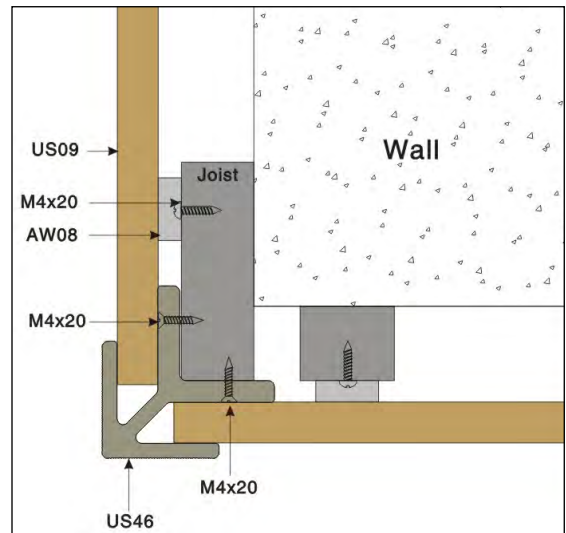

DIAGRAM 38

F Trim

- 3 The F trim will now be installed on the open side as shown in Diagram 39.

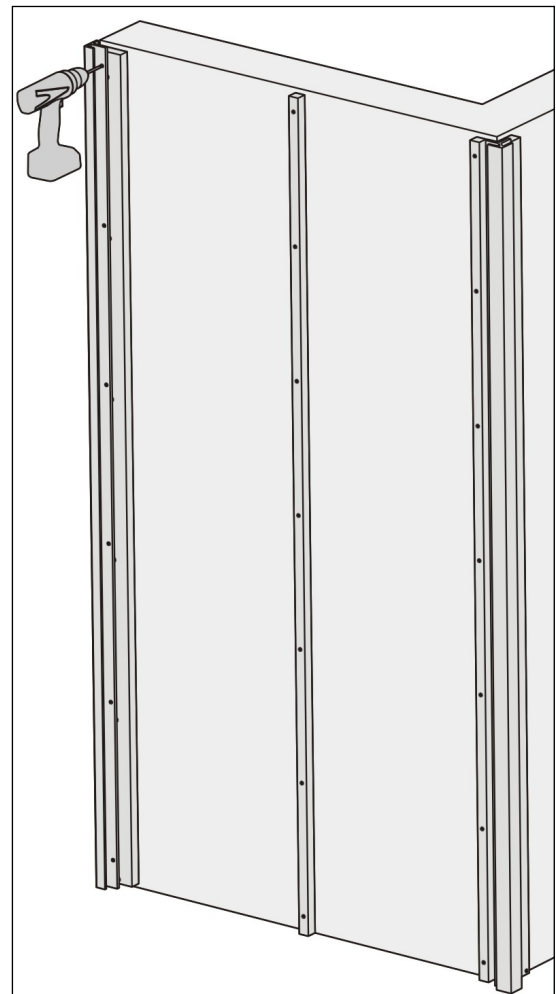

DIAGRAM 39

I Trim

- 4 The I trim will be installed on walls where one board does not go all the way across as shown below in Diagram 40.

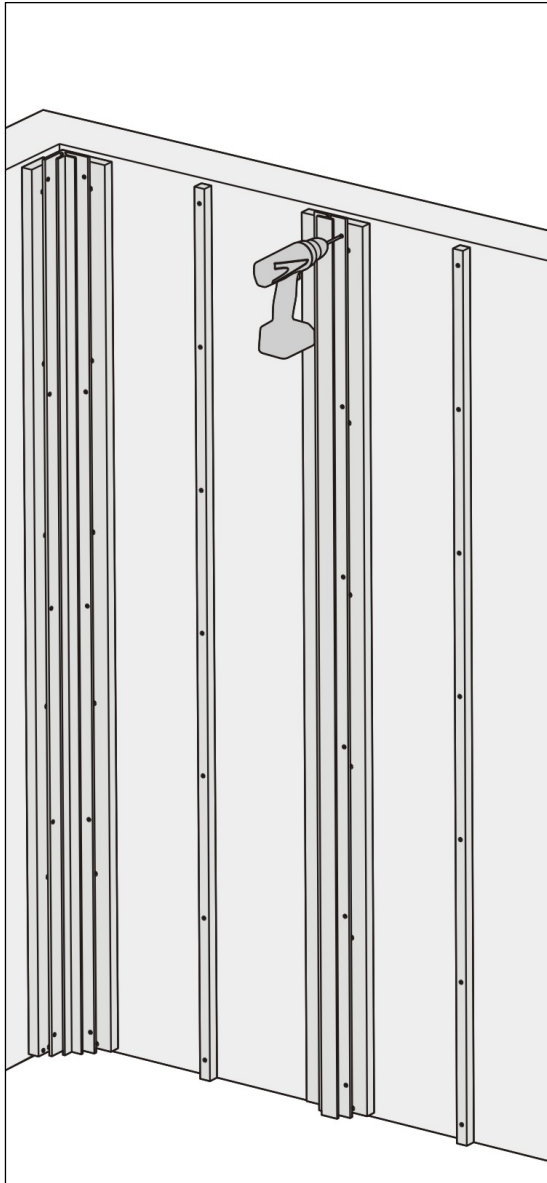

DIAGRAM 40

F Trim

- 5 The F trim will now be installed on the other open side as shown in Diagram 41.

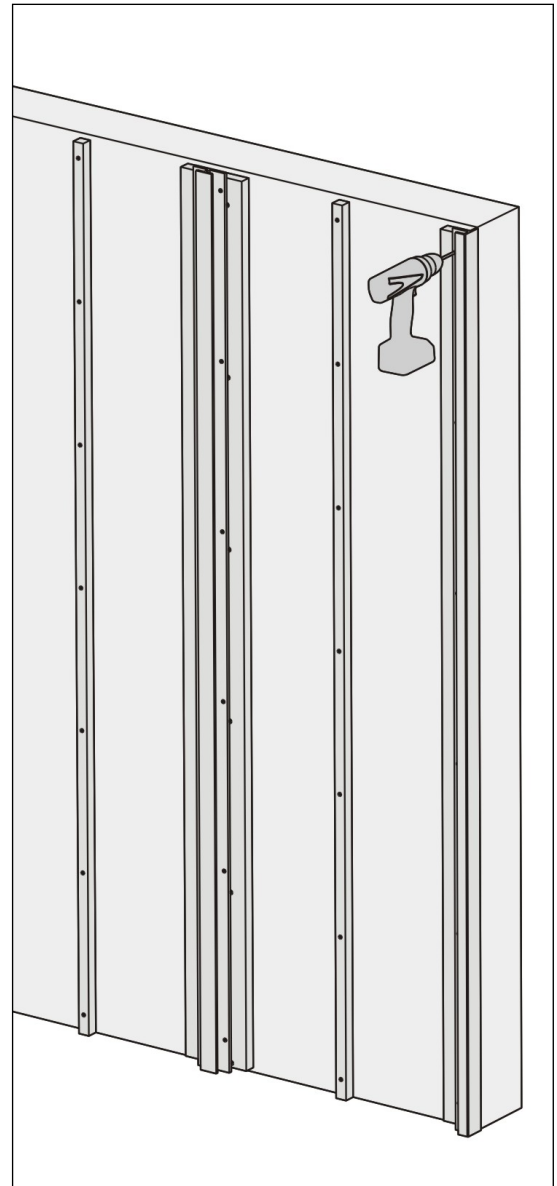

DIAGRAM 41

Starting Strip

- 6 Install the starting trim on the F trim and outside corner wall as shown in Diagram 42.

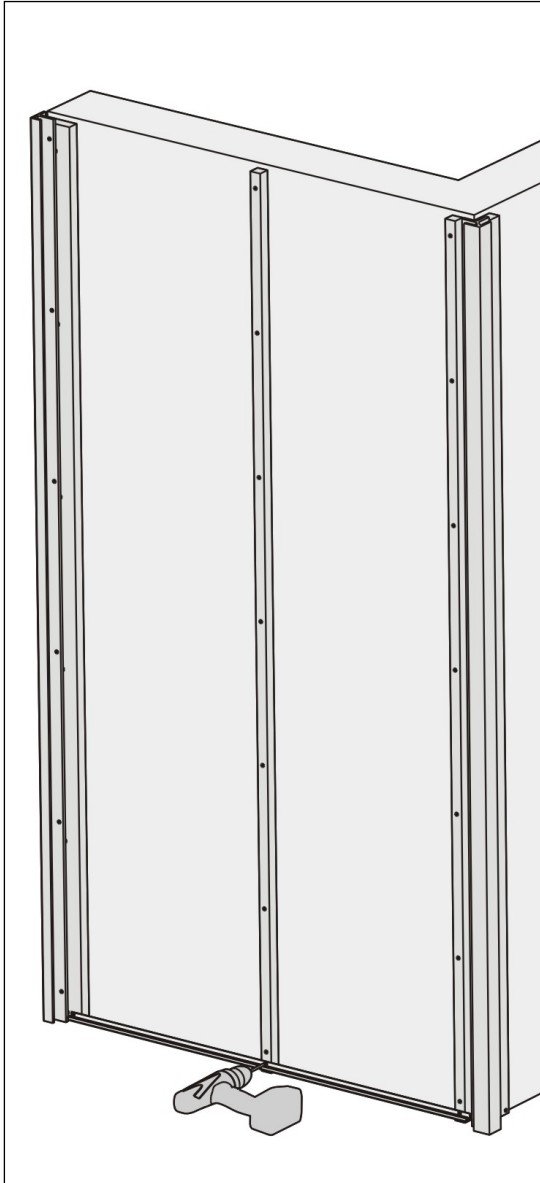

DIAGRAM 42

Wall Cladding Board

- 7 The siding board can now be installed over the starting trim as shown in Diagram 43 using the AW02 clips.

The siding board will need to be dropped in from the top of the wall in order to fit in both slots of the trims / corners.

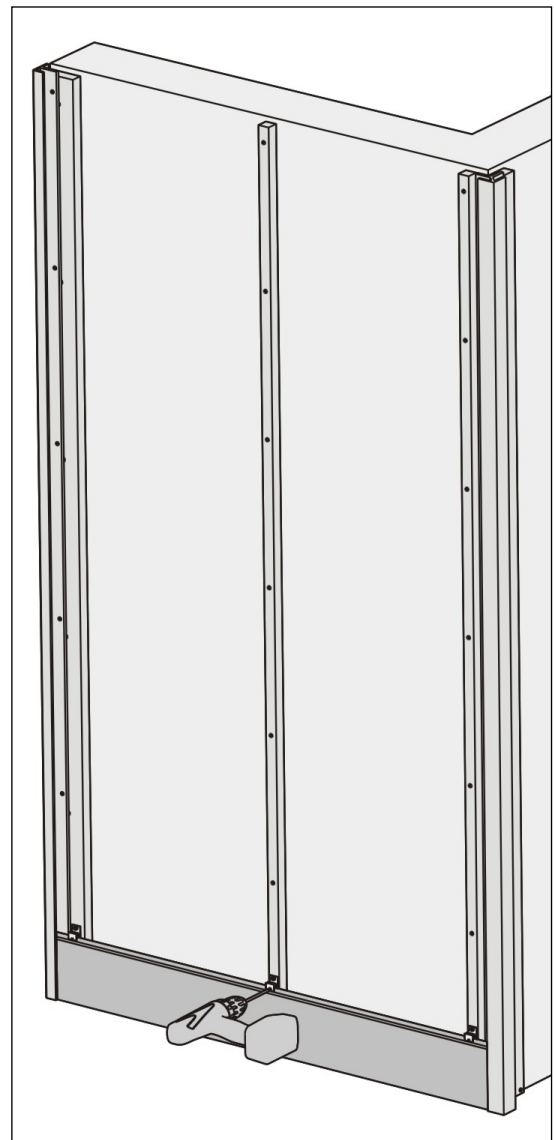

DIAGRAM 43

- 8 The rest of the wall cladding will be slotted in from the top and installed with AW02 clips as shown below in Diagram 44.

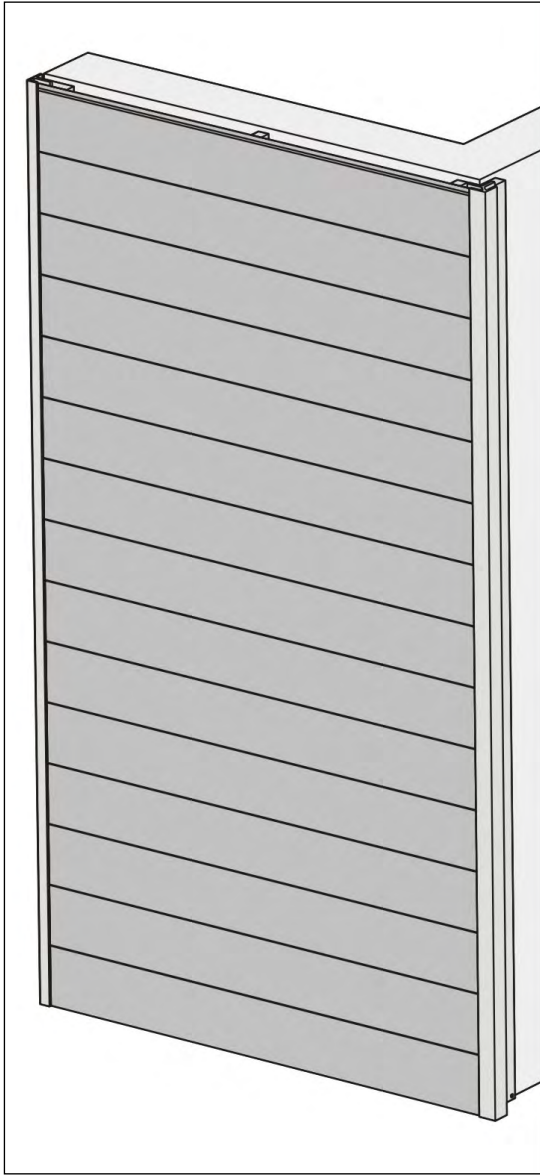

DIAGRAM 44

- 9 The other wall will be installed in the same manner as Diagram 45, and 46.

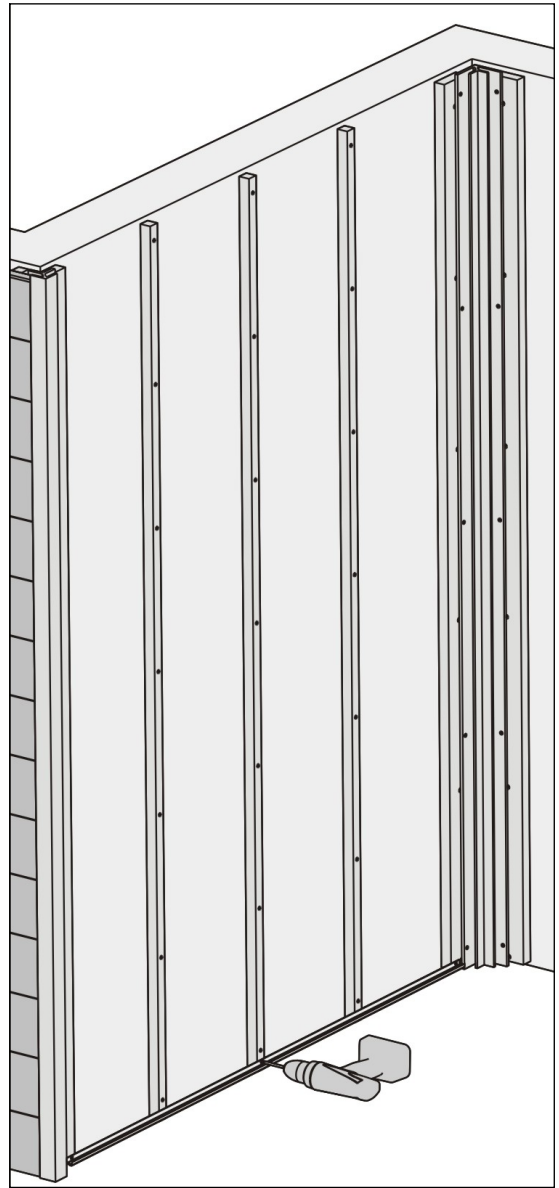

DIAGRAM 45

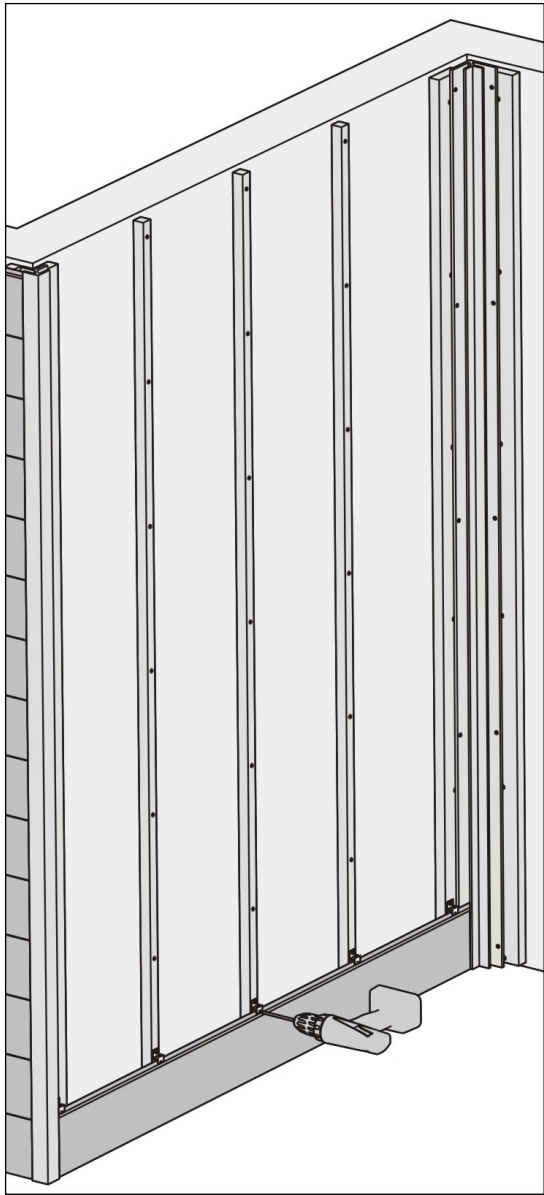

DIAGRAM 46

- 10** The completed wall should look like the following as shown in Diagram 47.

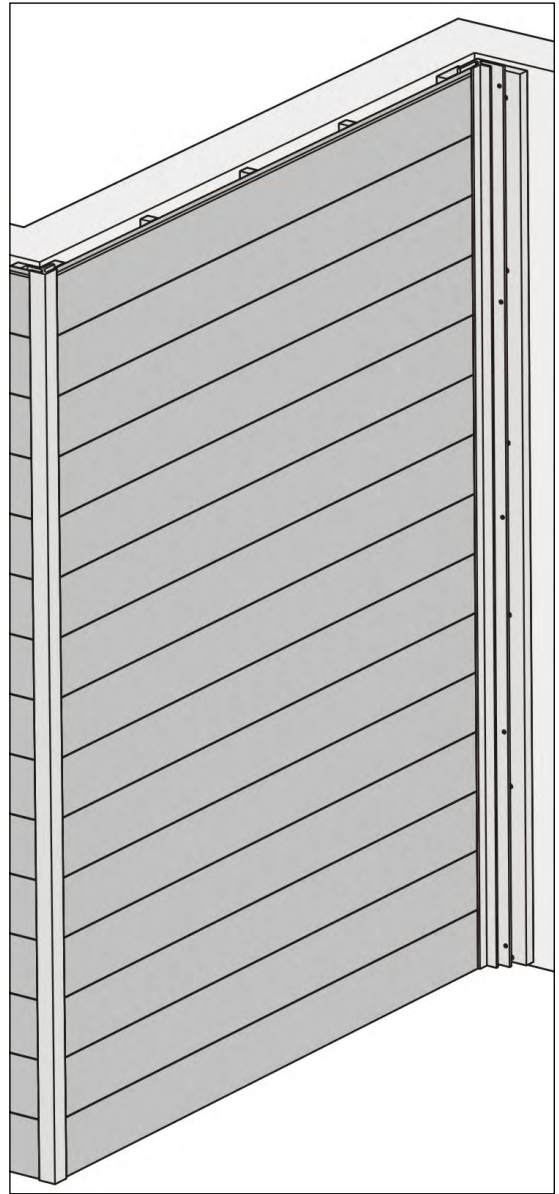

DIAGRAM 47

- 11 The walls utilizing the I Trim shown in Diagram 48 should also be done in the same manner as 49, 50, 51, 52, and 53.

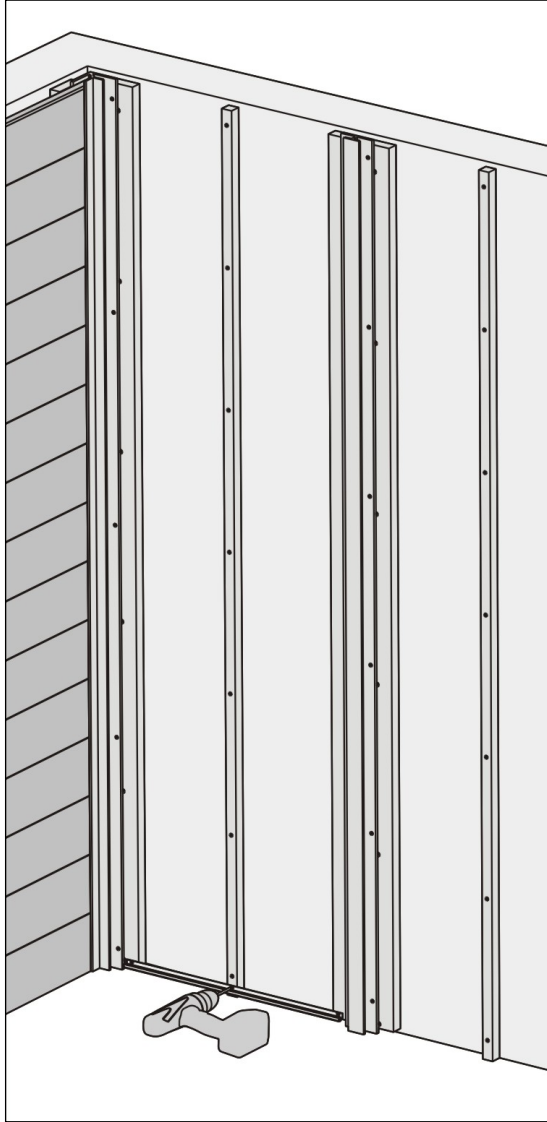

DIAGRAM 48

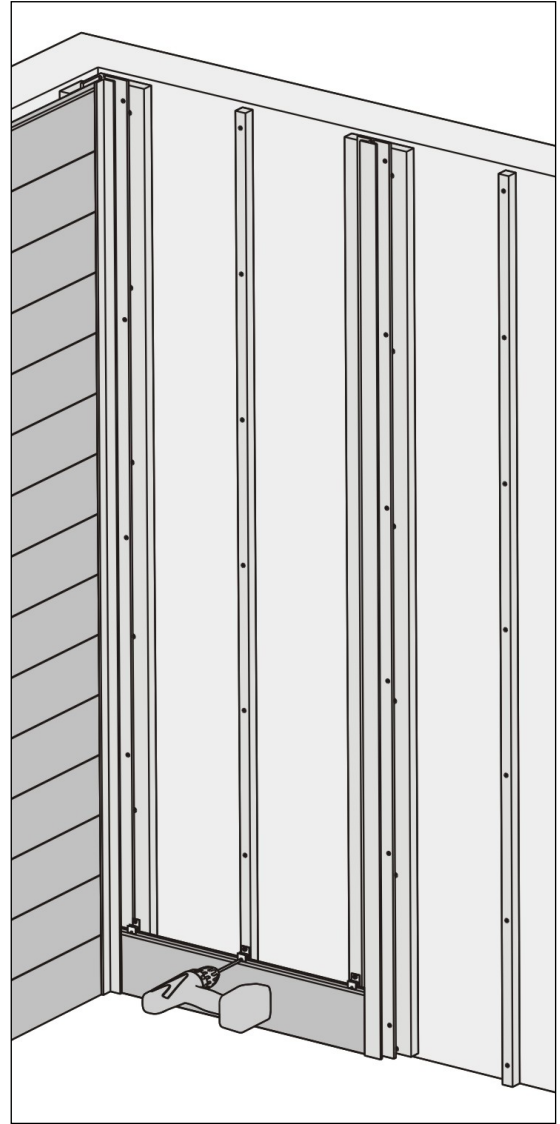

DIAGRAM 49

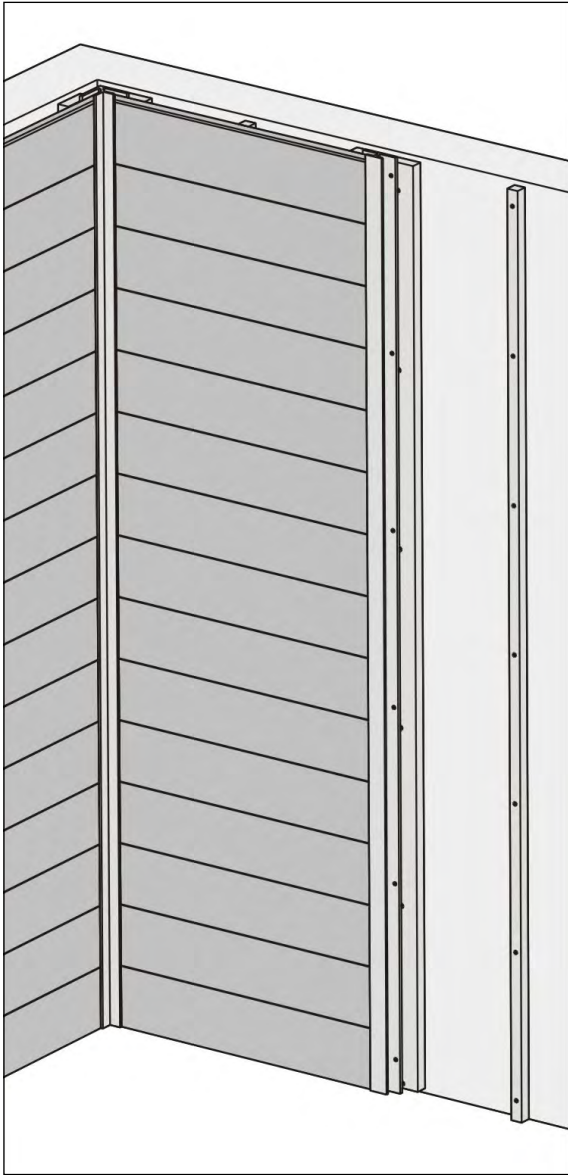

DIAGRAM 50

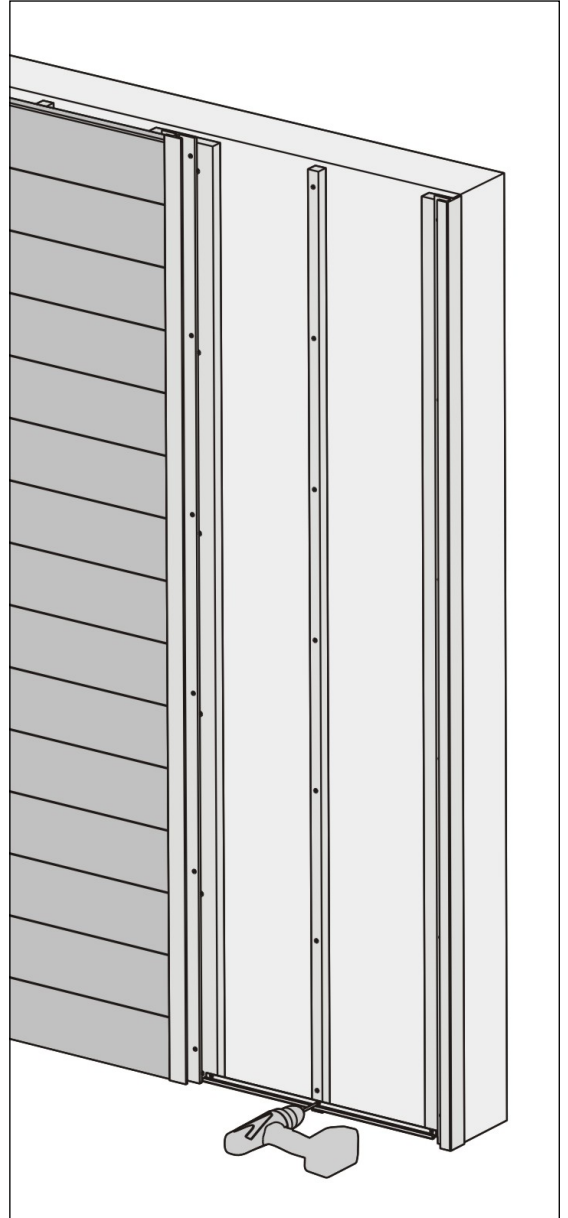

DIAGRAM 51

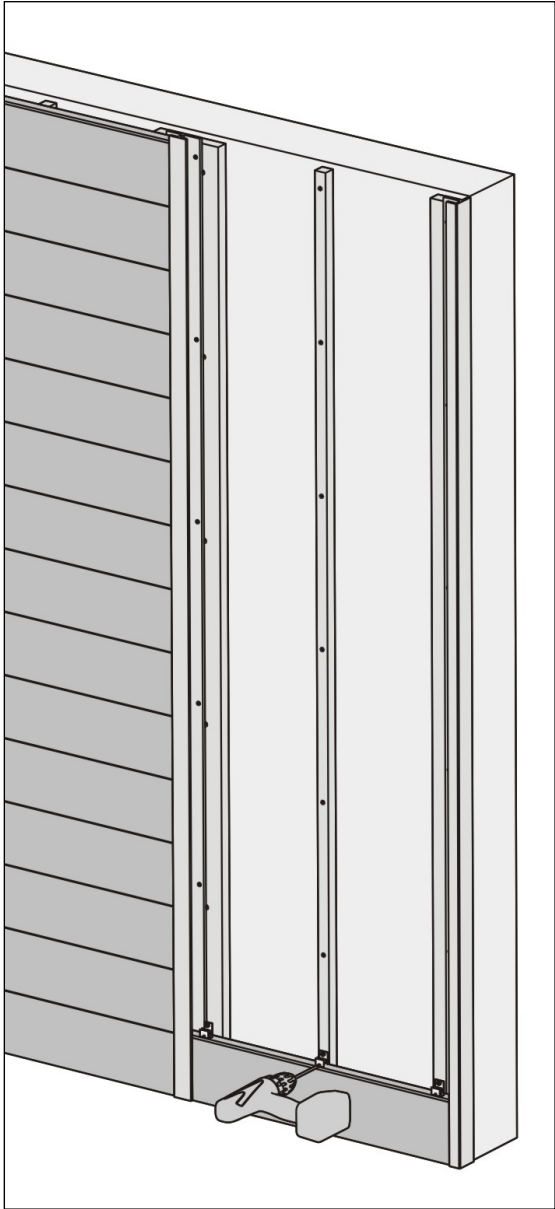

DIAGRAM 52

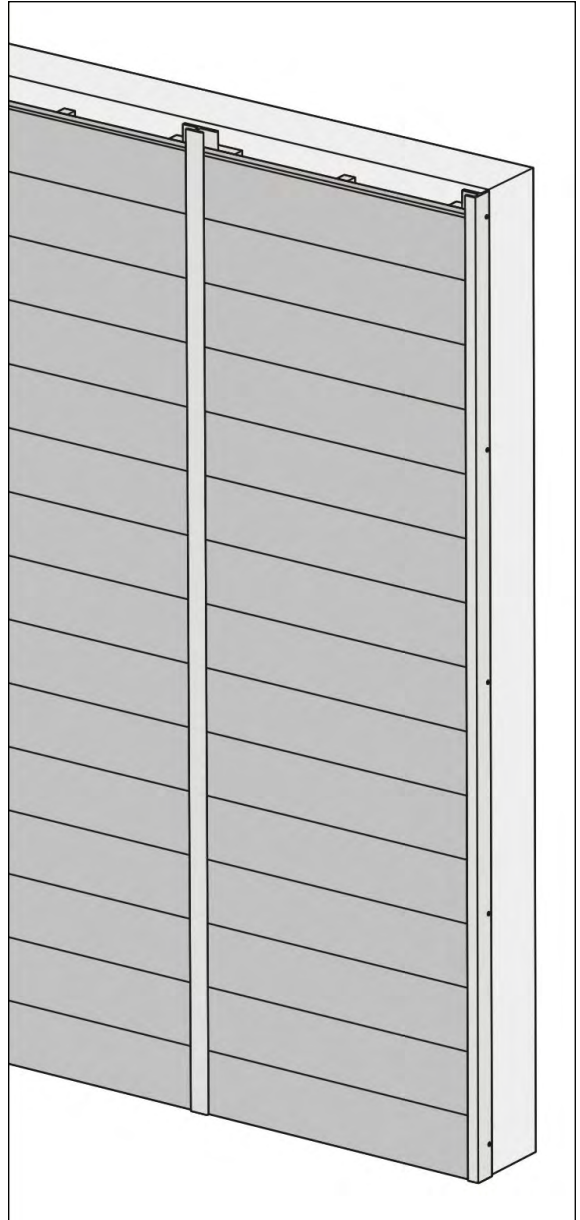

DIAGRAM 53

- 12** After completing all walls you should have the following installation as shown in Diagram 54.

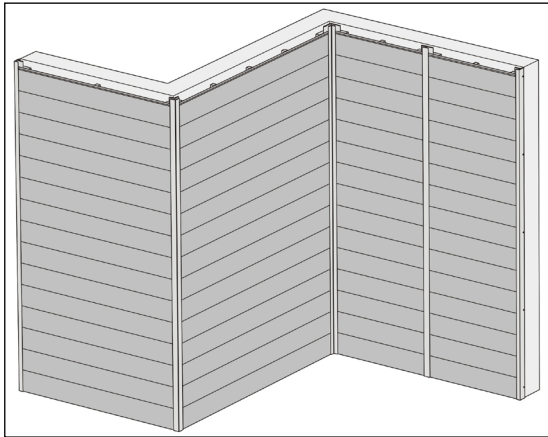

DIAGRAM 54

Finishing the last board

Option 1:

F Trim

- 1** Take the F trim and cut them to the length of the top of the cladding structure you are installing on as shown in Diagram 55.

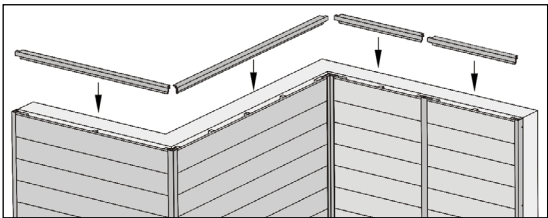

DIAGRAM 55

- 2** Cutting out a notch at both ends might be required to ensure that it fits around the joist as shown in Diagram 56.

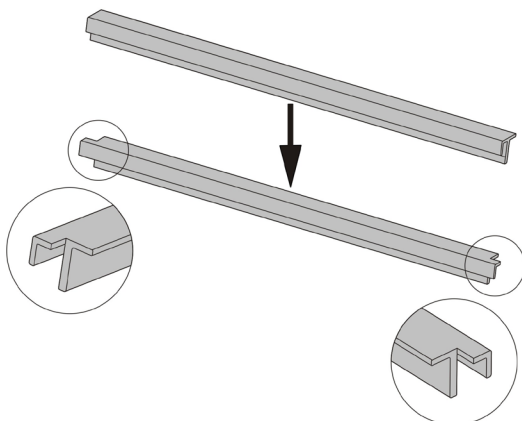

DIAGRAM 56

- 3** Now fix face the cut pieces to the tops of the joists as shown in Diagram 57.

Note: Always pre-drill before screwing unless using composite screws designed for non pre-drilling. The distance between each screw should be no more than 300 mm center to center.

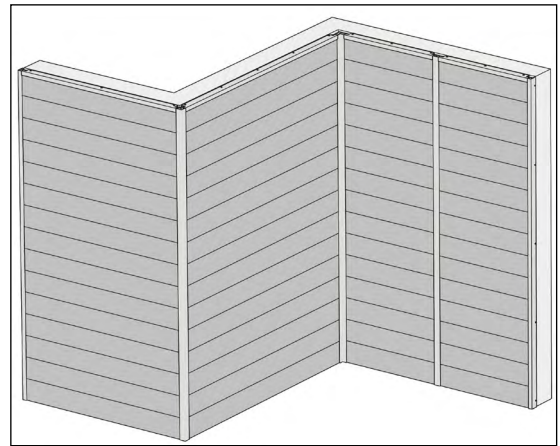

DIAGRAM 57

Option 2:

Wall Cladding Board

- 1** First measure the distance between the ceiling to the second to last wall cladding board as shown in Diagram 58.

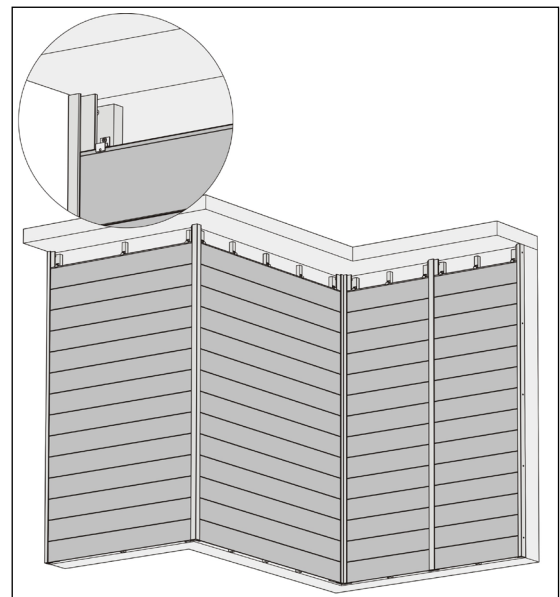

DIAGRAM 58

- 2 Install the T-7 gaskets onto the joists at 1 inch from the top of the ceiling as shown Diagram 59.

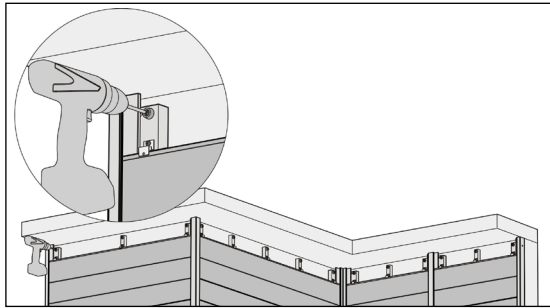

DIAGRAM 59

- 3 Take a wall cladding board and cut it down to the measured length from the ceiling to the second to the last wall cladding board as shown in Diagram 60.

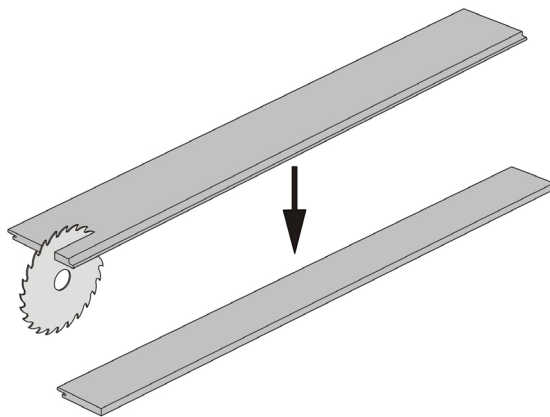

DIAGRAM 60

- 4 Take the wall cladding board and install it onto the clips and over the T-7 gaskets. Next pre-drill and face fix onto every joist as shown in Diagram 61, 62.

Note: When face fixing remember to first pre-drill a hole. The screw should be a minimum length of 1' 3/4 inch in order to ensure it goes through the board and into the joist underneath.

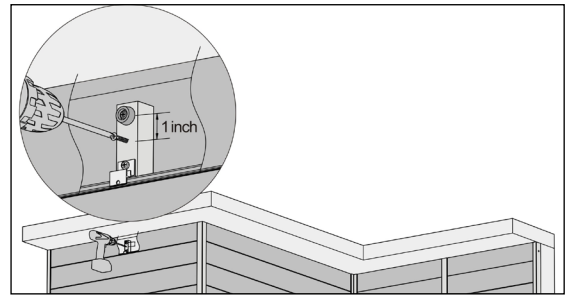

DIAGRAM 61

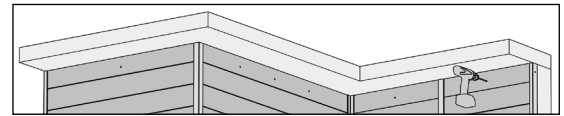

DIAGRAM 62

- 5 The final finished installation should look like Diagram 63.

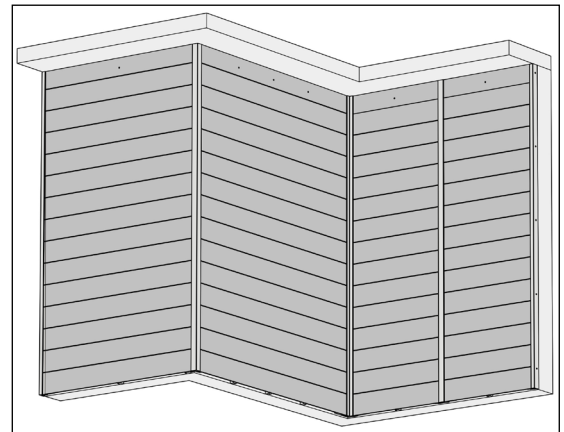

DIAGRAM 63

Window Installation

- 1 Windows should be installed after all wall cladding has been installed on the wall as shown in Diagram 64.

Note: This installation of the window will be done on joists and framing that are on wood.

If installation is done on a brick or concrete wall framing, metal joists, or wood, joists need to be added first in order to install the boards onto that structure. Installing directly on brick or concrete is not recommended.

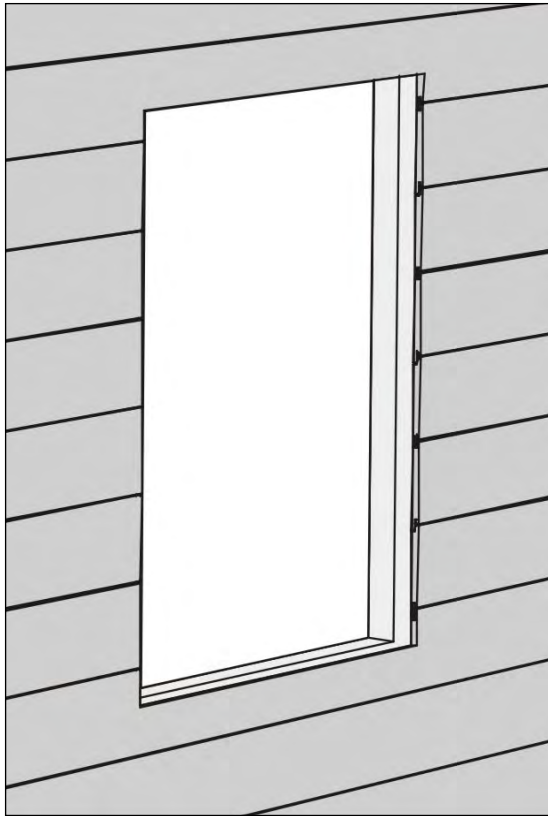

DIAGRAM 64

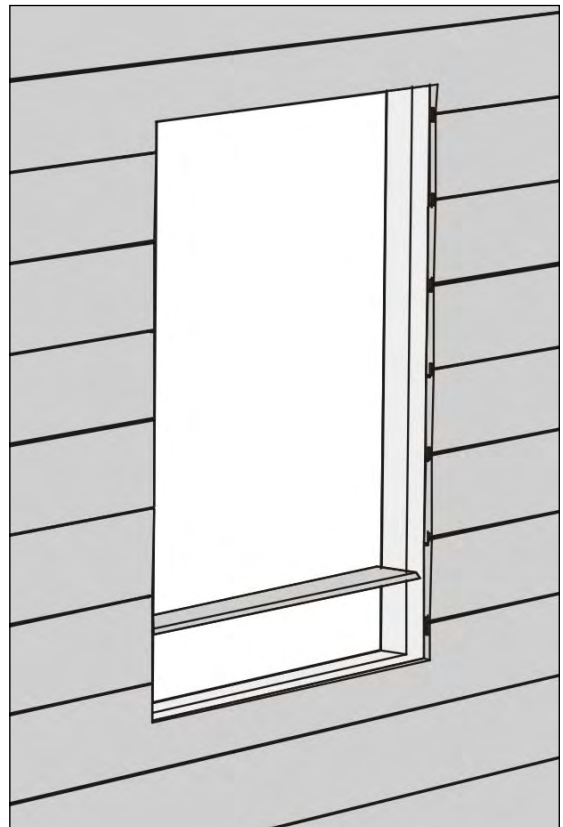

DIAGRAM 66

- 2 Take the wall cladding board and cut down the middle to create a rectangle to fit in the window as shown in Diagram 65.

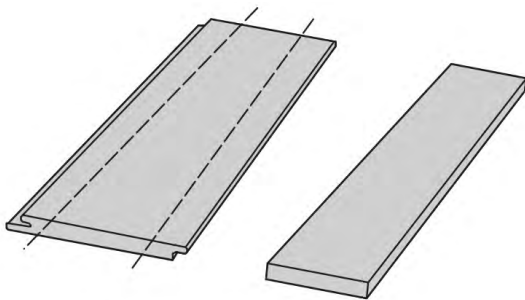

DIAGRAM 65

- 3 Take the cut pieces and install them to the frame of the window as shown below in Diagram 66 and 67.

Note: Always pre-drill before screwing unless using composite screws designed for non pre-drilling. The distance between each screw should be no more than 300 mm center to center.

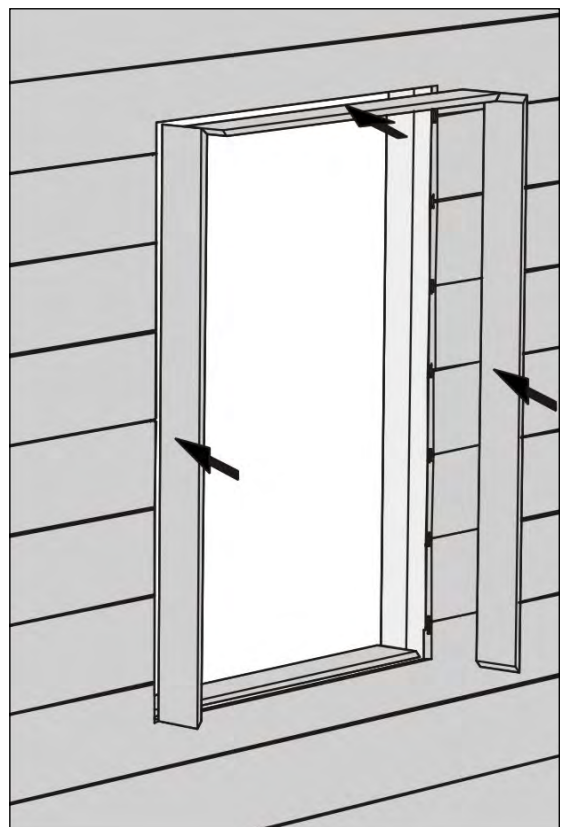

DIAGRAM 67

- 4 Take the F trim and cut to match the corners of the window as shown below in Diagram 68.

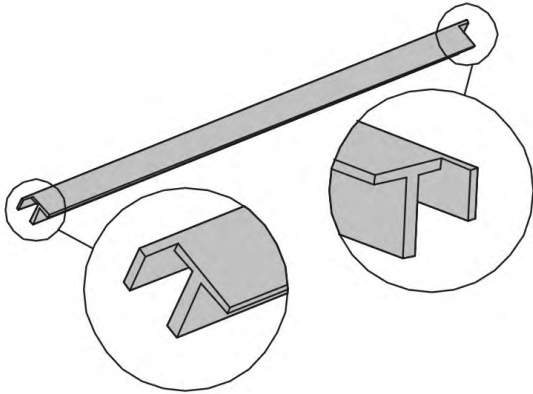

DIAGRAM 68

- 5 Install the cut F trim pieces over the cut composite wall cladding as show in Diagram 69 and 70.

Note: Always pre-drill before screwing unless using composite screws designed for non pre-drilling. The distance between each screw should be no more than 300 mm center to center.

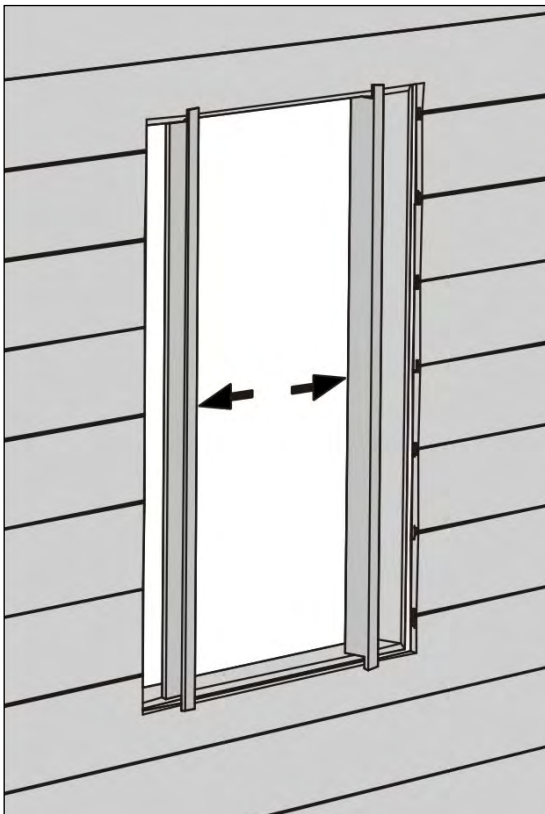

DIAGRAM 69

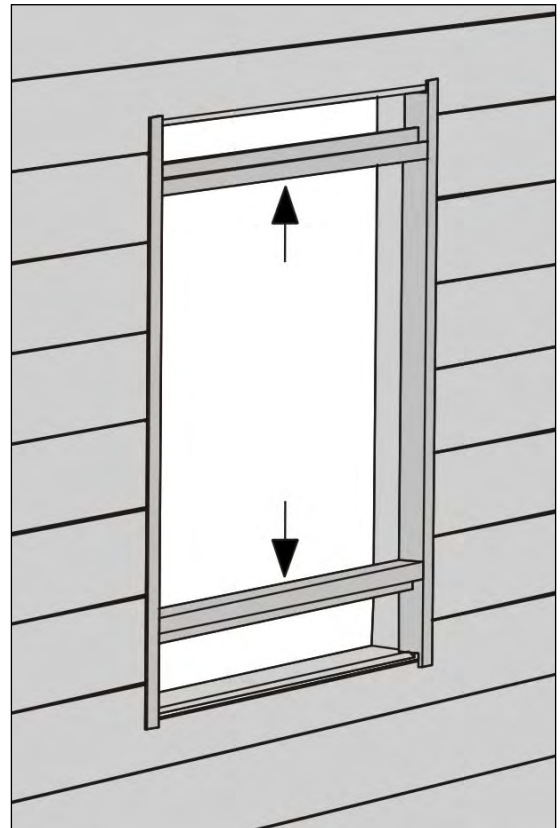

DIAGRAM 70

- 6 The completed window installation should look like Diagram 71.

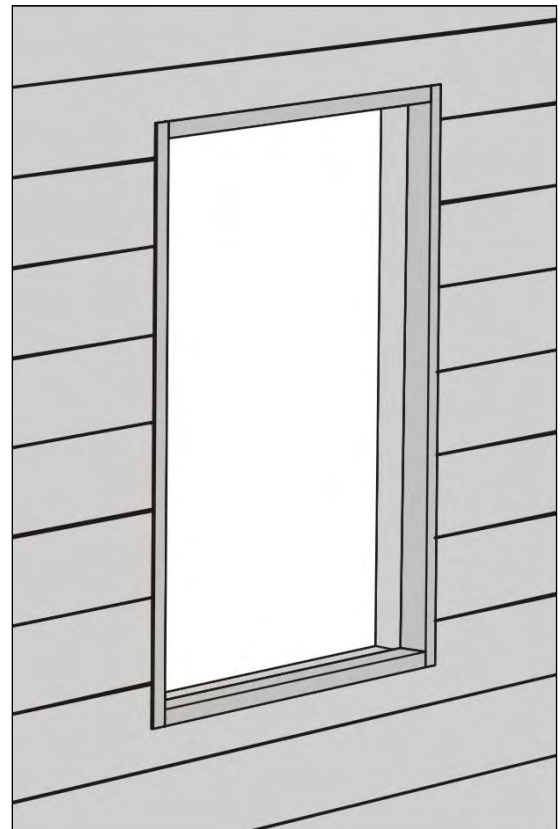

DIAGRAM 71

Ceiling Installation

- 1 The span for the ceiling should be 300mm (12 inches) center from center as shown in diagram 72.

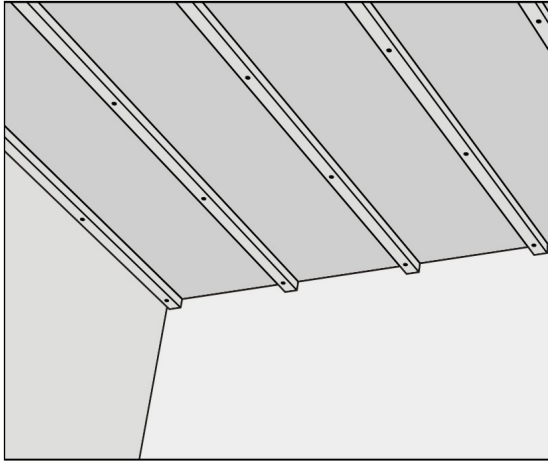

DIAGRAM 72

- 2 First install the AW-02 starting aluminum strip to the joist as shown in Diagram 73.

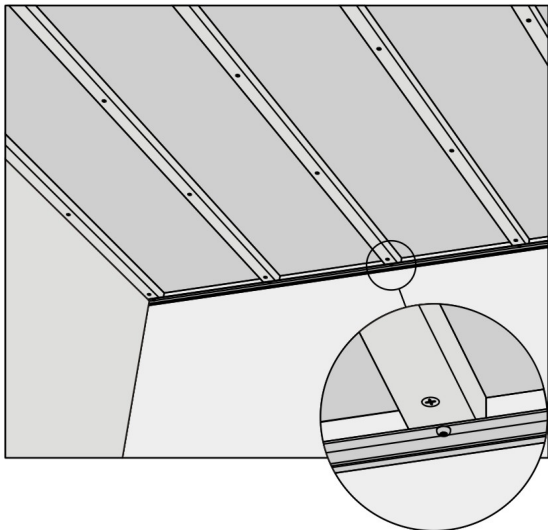

DIAGRAM 73

- 3 Next take the first board and install it on the AW-02 strip as shown in Diagram 74.

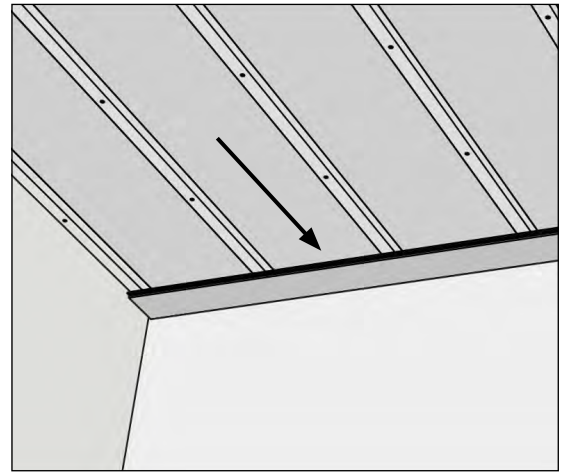

DIAGRAM 74

- 4 On each joist place an AW-08 clip and fix the clip to the joists as shown in Diagram 75.

Note: One of the clips needs to lock the board, if you are unfamiliar with this, please go to page 8 of this installation guide to understand how to lock the board with AW-08.

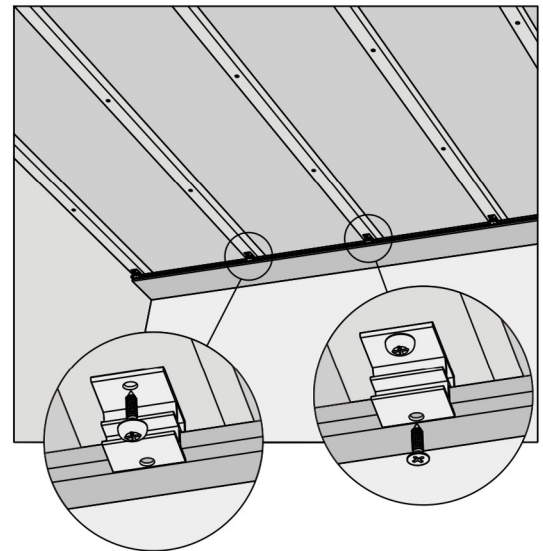

DIAGRAM 75

- 5 Take the next board and slide it over the clips positioned on the first board as shown in Diagram 76.

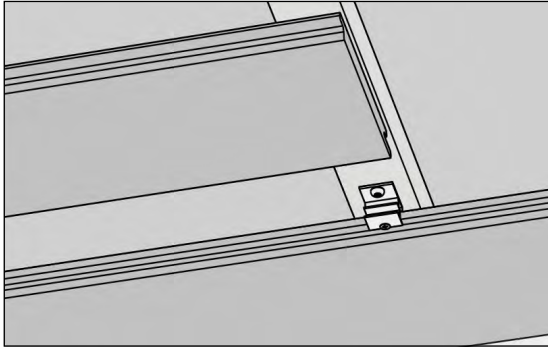

DIAGRAM 76

- 6 Repeat steps 4, 5, and 6 and install the rest of the boards as shown in Diagram 77.

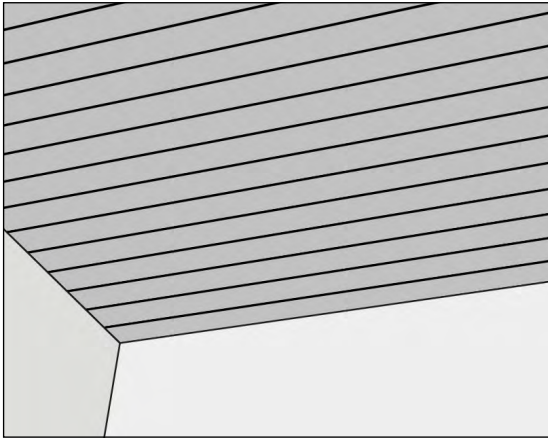

DIAGRAM 77

- 7 Install a 8mm thick wood piece on each joist or a strip that is 8mm thick for installing the last board as shown in Diagram 78.

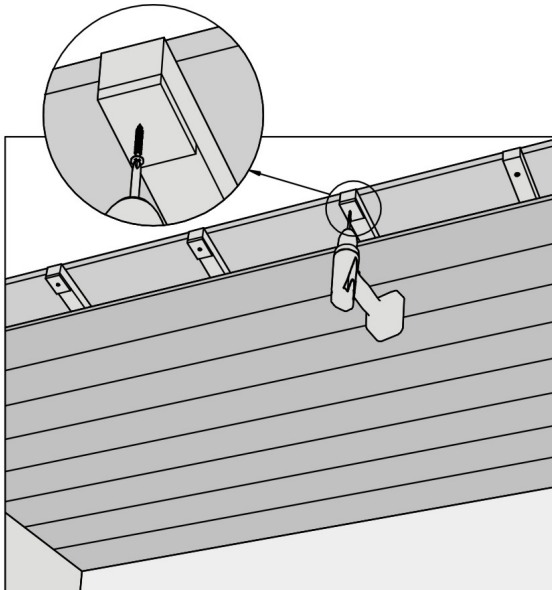

DIAGRAM 78

- 8 Place the last board and pre-drill as shown in Diagram 79.

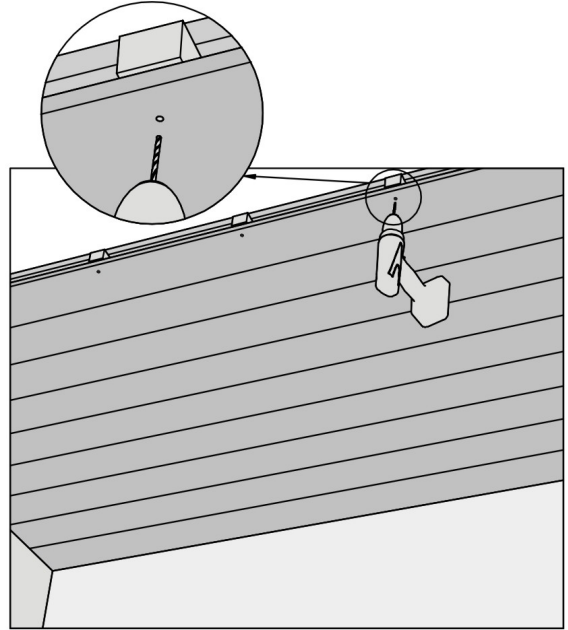

DIAGRAM 79

- 9 Next take screws and fix the joists through the pilot holes as shown in Diagram 80.

Note: Do not over tighten the screws.

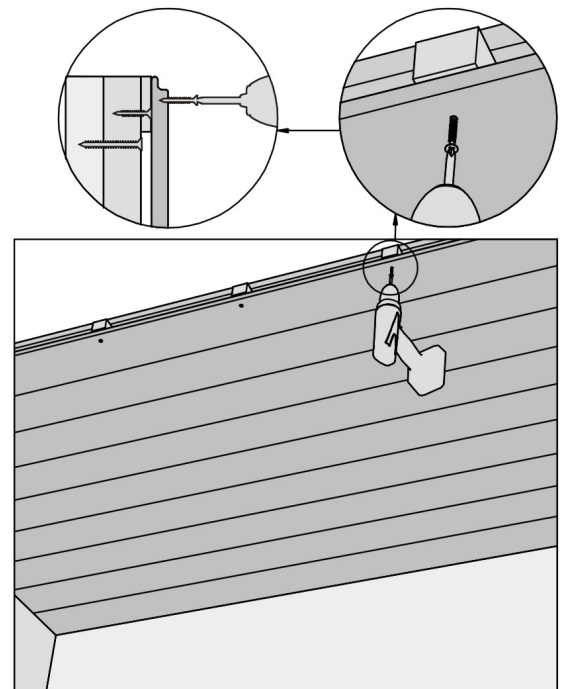

DIAGRAM 80



Wall Cladding Installation Guide

v20190524

©2019 Huidong Meixin Plastic Lumber Products Manufacturing Co., Ltd.
NewTechWood® is a registered trademark of Huidong Meixin Plastic Lumber Products Manufacturing Co., Ltd. To obtain a copy of the most current version of this installation guide, visit us online at www.newtechwood.com.

